

## LED Strip Light

### NRP-ST24 COB Series



Item Code	Input Voltage	Watt	Ra	Lm/M	Cutting	LED QTY	LED Type	Beam Angle	IP	CCT
NRP-ST24-COB-10W-3000K	DC24V	10W/M	>90	919lm/w	41.67mm	384Pcs	COB	120°	IP20	3000K <span style="color: orange;">■</span>
NRP-ST24-COB-10W-4000K	DC24V	10W/M	>90	1032lm/w	41.67mm	384Pcs	COB	120°	IP20	4000K <span style="color: gold;">■</span>
NRP-ST24-IP65-COB-10W-3000K	DC24V	10W/M	>90	941lm/w	41.67mm	384Pcs	COB	120°	IP65	3000K <span style="color: orange;">■</span>
NRP-ST24-IP65-COB-10W-4000K	DC24V	10W/M	>90	1030lm/w	41.67mm	384Pcs	COB	120°	IP65	4000K <span style="color: gold;">■</span>

Note: IP20 can only be used indoors, ip65 can be used outdoors

#### Dimensions in mm

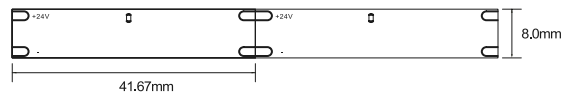

# LED Strip Light

## NRP-ST24 2835 Series

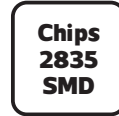
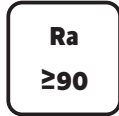
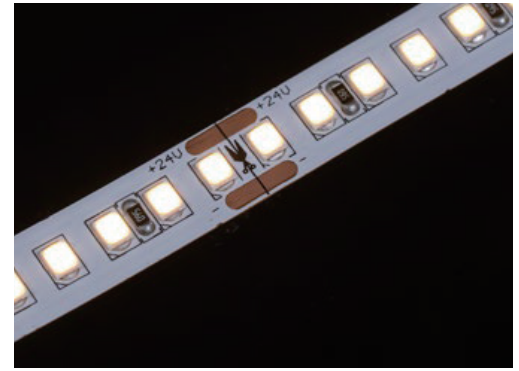

Item Code	Input Voltage	Watt	Ra	Lm/M	Cutting	LED QTY	LED Distance	Beam Angle	IP	CCT
NR-ST24-60-5W-3000K	DC24V	5W/M	>90	438lm/w	100mm	6Pcs	8mm	120°	IP20	3000K
NR-ST24-60-5W-4000K	DC24V	5W/M	>90	465lm/w	100mm	6Pcs	8mm	120°	IP20	4000K
NR-ST24-120-9W-3000K	DC24V	9W/M	>90	805lm/w	50mm	12Pcs	10mm	120°	IP20	3000K
NR-ST24-120-9W-4000K	DC24V	9W/M	>90	825lm/w	50mm	12Pcs	10mm	120°	IP20	4000K
NRP-ST24-128-23W-3000K	DC24V	23W/M	>90	2693lm/w	63mm	8Pcs	12mm	120°	IP20	3000K
NRP-ST24-128-23W-4000K	DC24V	23W/M	>90	2775lm/w	63mm	8Pcs	12mm	120°	IP20	4000K
NRP-ST24-168-14W-3000K	DC24V	14W/M	>95	1565lm/w	42mm	7Pcs	10mm	120°	IP20	3000K
NRP-ST24-168-14W-4000K	DC24V	14W/M	>95	1971lm/w	42mm	7Pcs	10mm	120°	IP20	4000K
NR-ST24-IP65-60-5W-3000K	DC24V	5W/M	>90	410lm/w	100mm	6Pcs	10mm	120°	IP65	3000K
NR-ST24-IP65-60-5W-4000K	DC24V	5W/M	>90	415lm/w	100mm	6Pcs	10mm	120°	IP65	4000K
NRP-ST24-IP65-168-14W-3000K	DC24V	14W/M	>95	1430lm/w	42mm	7Pcs	12mm	120°	IP65	3000K
NRP-ST24-IP65-168-14W-4000K	DC24V	14W/M	>95	1660lm/w	42mm	7Pcs	12mm	120°	IP65	4000K

Note: IP20 can only be used indoors, ip65 can be used outdoors

### Dimensions in mm

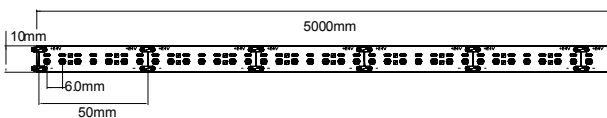

### POLAR AND CONE DIAGRAM

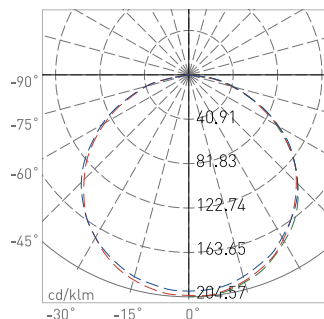

### PHOTOMETRIC OF 1M STRIP

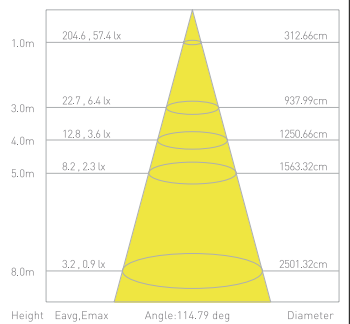



# LED Strip Light

## Silicon Neon Series

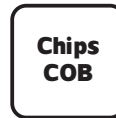
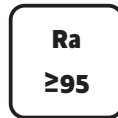

Item Code	Input Voltage	Watt	Ra	Lm/M	Cutting	LED QTY	Body Size	Beam Angle	IP	CCT
NRP-NE24-IP67-9W-3000K	DC24V	9W/M	>95	766lm/w	50mm	120Pcs	W10*H10mm	75°	IP67	3000K
NRP-NE24-IP67-9W-4000K	DC24V	9W/M	>95	856lm/w	50mm	120Pcs	W10*H10mm	75°	IP67	4000K

### WIRING METHOD

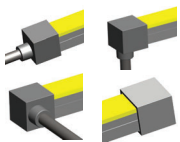

### BENDING DIAMETER

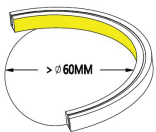

### ACCESSORY OPTION

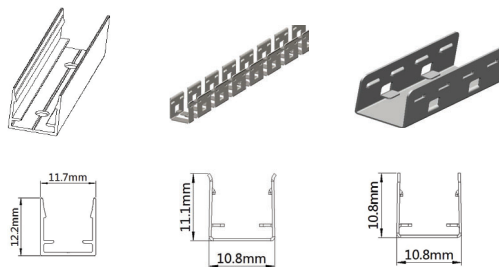

### PRODUCT FEATURES

- Micro cutting, flexible space installation
- Excellent flexibility for proper bending and easy modeling
- Uniform lighting
- Silicone material, Excellent weather, corrosion and UV resistance, environmental protection
- High quality circuit for stable and reliable perform
- Working temperature:-30~50 C

### Dimensions in mm

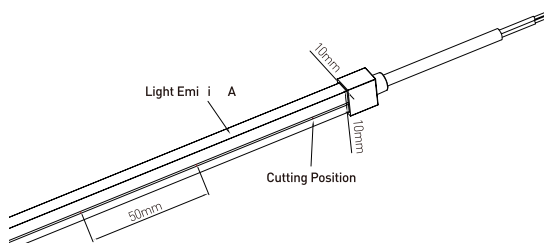

### POLAR AND CONE DIAGRAM

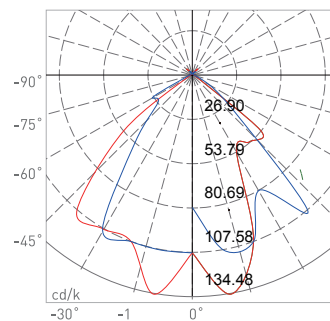

### PHOTOMETRIC OF 1M STRIP

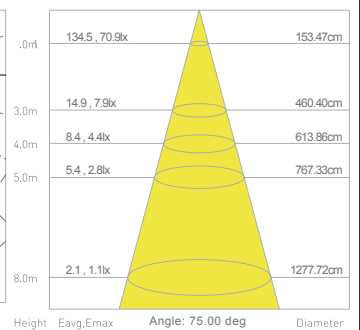

# LED Strip Solution

Ra/CRI > 80/90



ONE BIN  
SDCM<5

LED

NANO/IP65

ET/IP67

EG/IP65

EF/IP67

EGR/IP65

IP process

## Installation



Stick-on

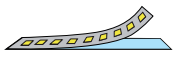

Heat Sink

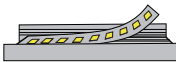

Profile



Clip

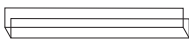

PC carrier

## Package

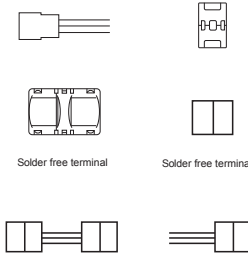
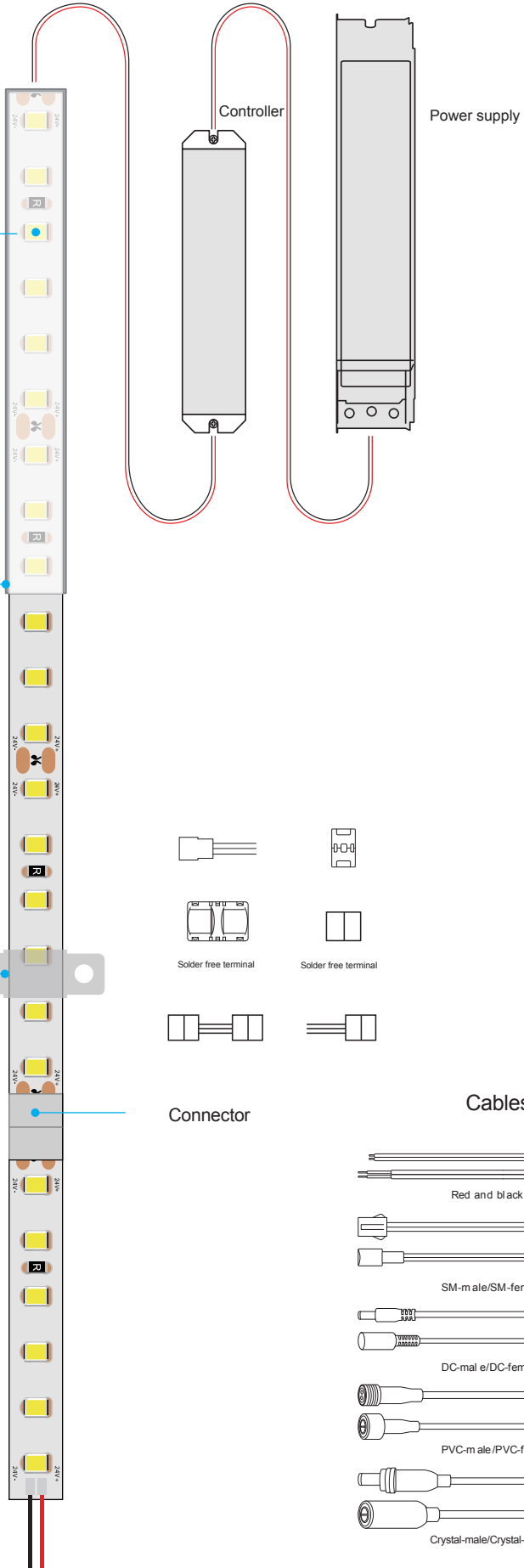
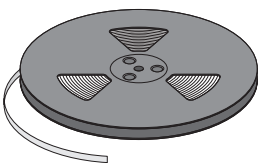

## Connector

## Cables

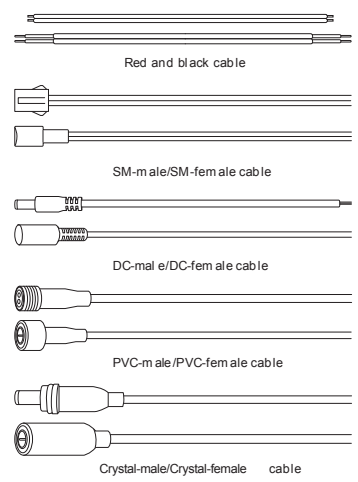

# Silicone Neon Strip Solution

Ra/CRI > 80/90



ONE BIN  
SDCM<5

### Wire & Gum filler

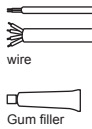

### Package

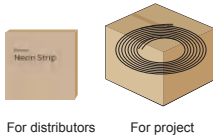

LED

End cap

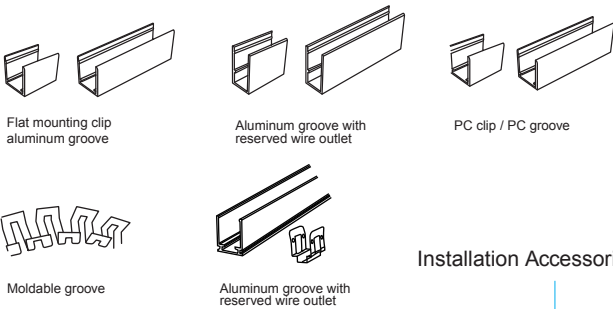
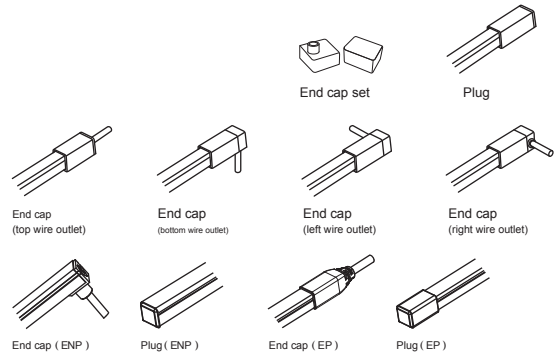
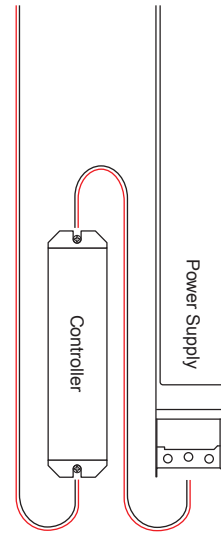

### Installation Accessories

Cutting line

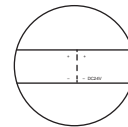

Connector

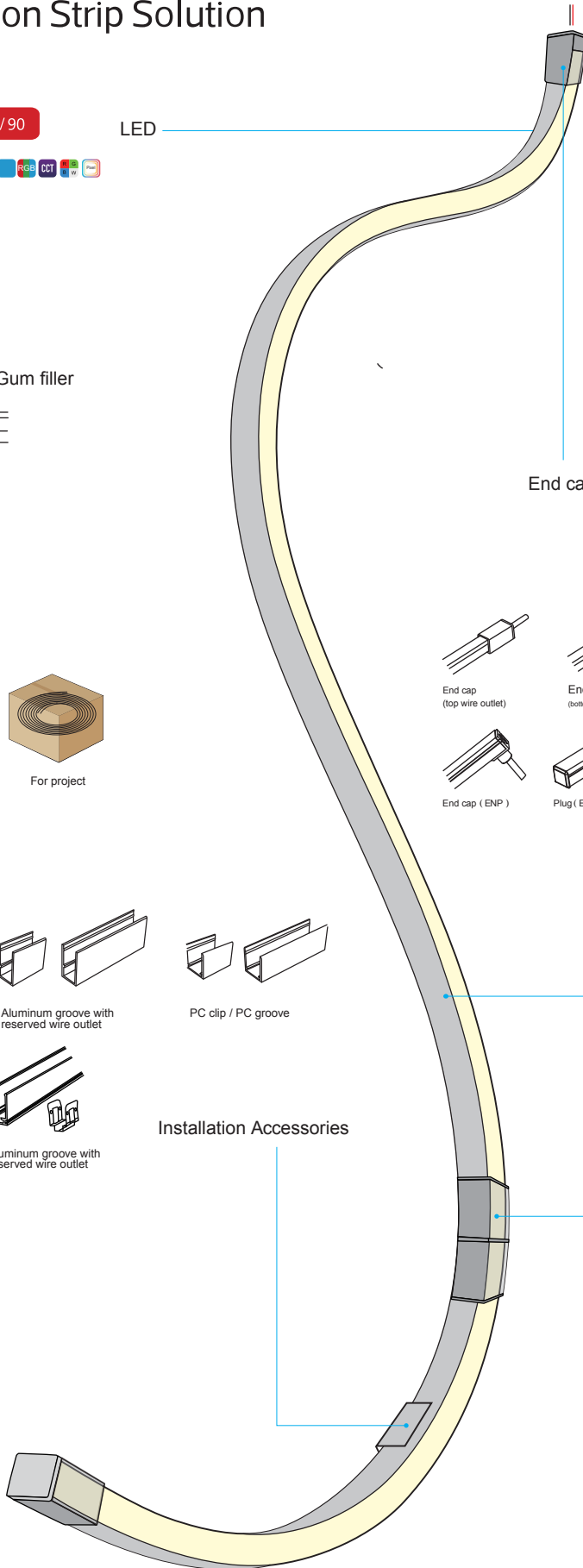
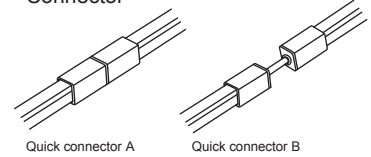

## LED Strip Power Supply

Item Code	Input Voltage(AC)	Input Current(A)	Output Voltage(DC)	Output Current(A)	IP	Watt
NR-PS-60W	100-240V	0.6A	24V	2.5A	20	60
NR-PS102-24V-60W	100-240V	0.6A	24V	2.5A	20	60
NR-PS102-24V-60-IP65	100-240V	0.6A	24V	2.5A	65	60
NR-PS-100W	100-240V	1A	24V	4.2A	20	100
NR-PS102-24-150W	100-240V	1.5A	24V	6.3A	20	150
NR-PS-150W	100-240V	1.5A	24V	6.2A	20	150
NR-PS-360W	100-240V	3.6A	24V	15A	20	360



**NOTE:the power supply should not exceed 80% of the rated power for long periods of time!**

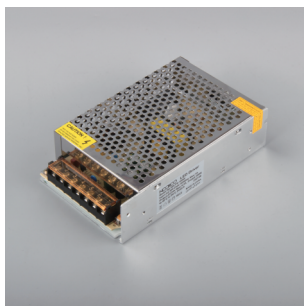

NR-PS-60W



NR-PS102-24V-60W



NR-PS102-24V-60-IP65

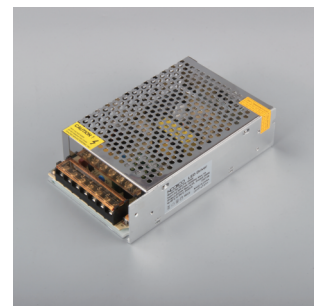

NR-PS-100W



NR-PS102-24-150W

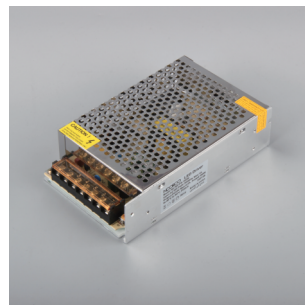

NR-PS-150W



NR-PS-360W

## Recommended spare parts

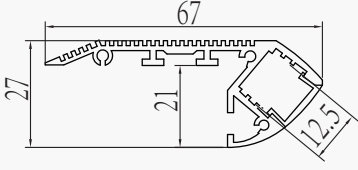
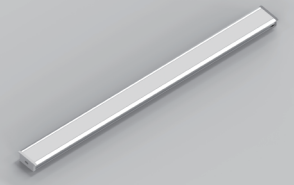
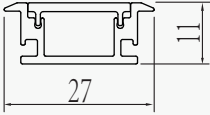
Name	Item Code	Picture	Note
Aluminium Profile	NR-355		
Aluminium Profile	NR-XT-210		

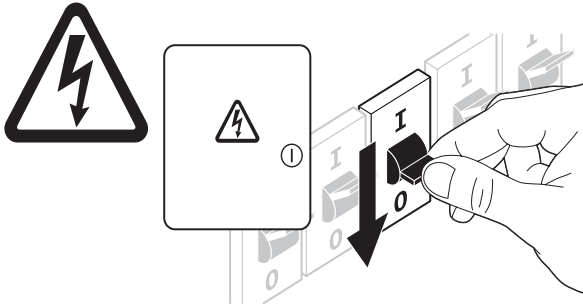

1

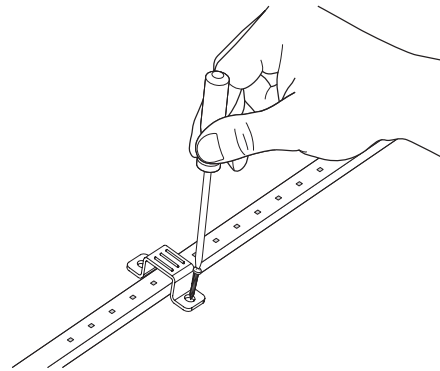

2

Installation



Stick-on



Heat Sink

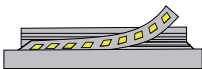

Profile



Clip

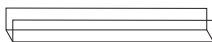

PC carrier

3

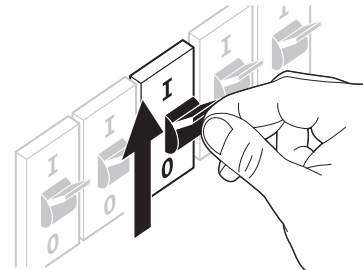

4

Disconnect mains power before installation, please use the clamp to fix the strip, turn on the power after strip is fixed

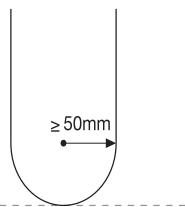
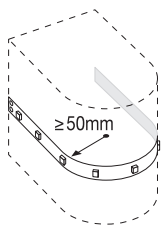



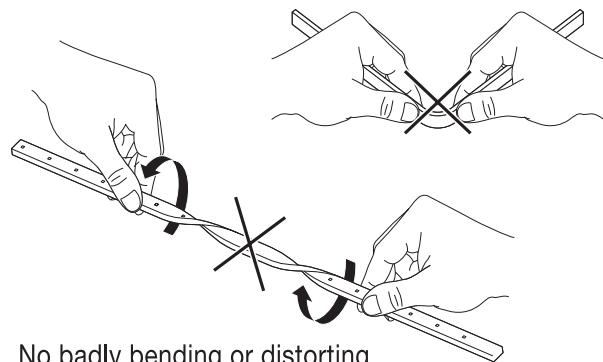













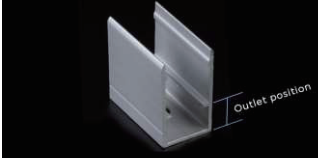
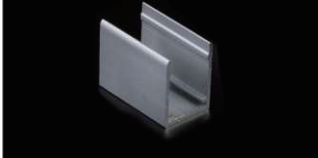



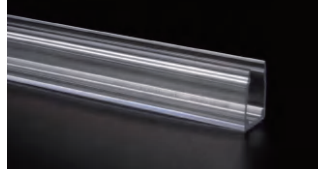

The radius when bending should be more than 50mm



No badly bending or distorting

Warning

<p><b>End cap</b></p>	<p>Top wire outlet</p> 	<p>Bottom wire outlet</p> 	<p>Left wire outlet</p> 	<p>Right wire outlet</p> 
				
<p><b>Mounting clip</b></p>	<p>Aluminum clip (outlet)</p>  <p>Outlet position</p>	<p>Aluminum clip</p> 	<p>PC clip</p> 	
			 <p>Transparent and invisible</p>	
<p><b>Mounting groove</b></p>	<p>Aluminum groove</p> 	<p>Aluminum groove (outlet)</p>  <p>Outlet position</p>	<p>PC groove</p> 	
		 <p>To hide the outlet</p>	 <p>Transparent and invisible</p>	
<p>Aluminum groove with reserved wire</p>	<p>outlet position</p>  <p>Protection for the neon strip</p>	<p>Side bend</p> 	<p>Top bend</p> 	
	 <p>Clip for fixing</p>	