

LED OUTDOOR BURIED LAMP

4011-3
IP67

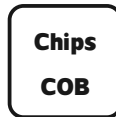
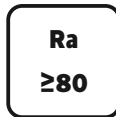

| Item Code | P (W) | CCT (K) | Beam angle | Output (lm) | lm/w | Dimensions in mm | | kg |
|-----------|-------|---------|------------|-------------|------|------------------|----|-------|
| | | | | | | A | B | |
| 4011-3 | 3 | 3000 | 36° | 210 | 70 | Φ65 | 75 | 0.454 |

Dimensions in mm

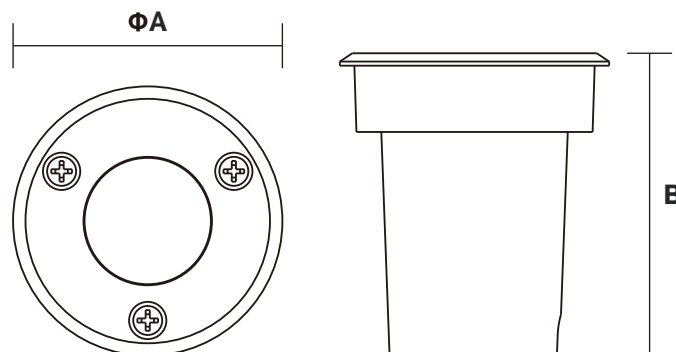

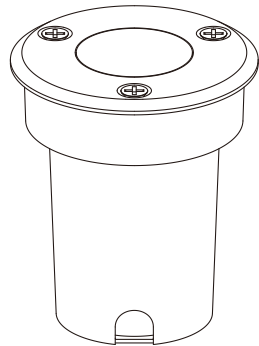
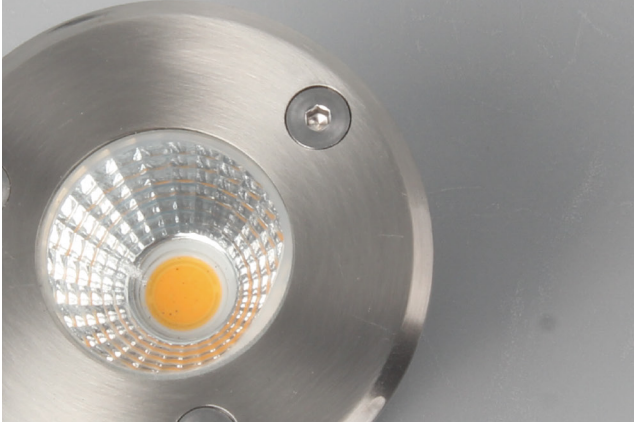

Description:
LED OUTDOOR BURIED LAMP

Main material:
Aluminum+Engineering plastics

Specification
Energy saving, up to 85% energy saving comparing to standard halogen and incandescent lamps
High quality light, high color rendering, less heat, no UV or IR radiation
Build-in LED Driver
IP65

Applications

- . Park
- . Square
- . Tourist attraction
- . Corridor

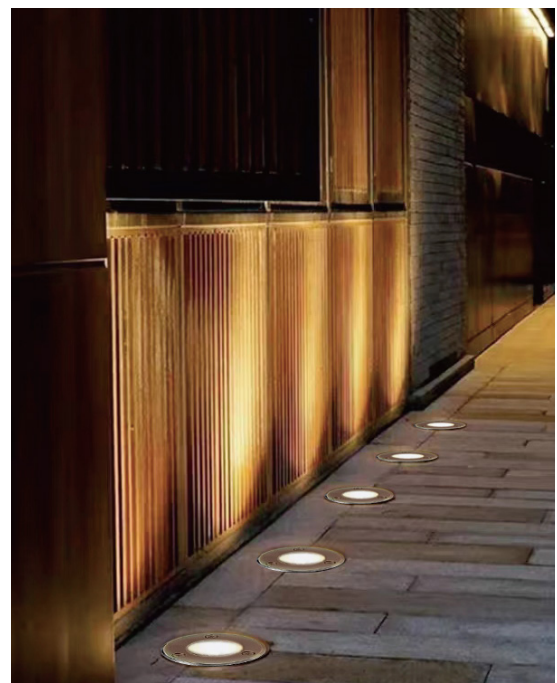
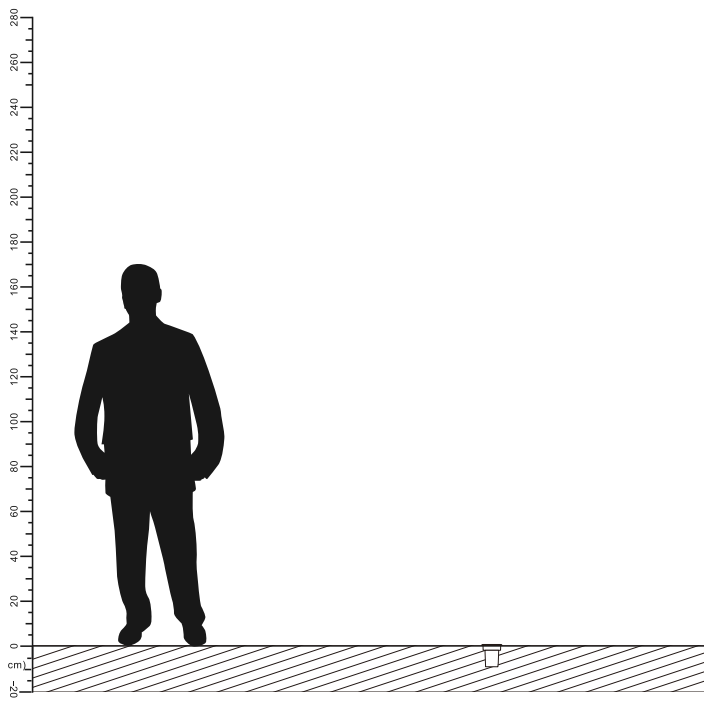

LUMINOUS INTENSITY DISTRIBUTION DIAGRAM

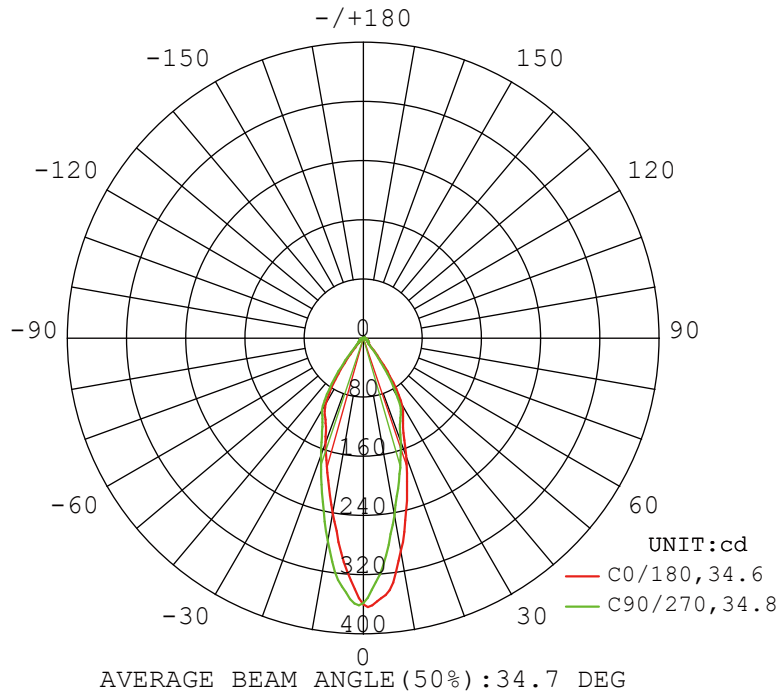

Illuminance at a Distance

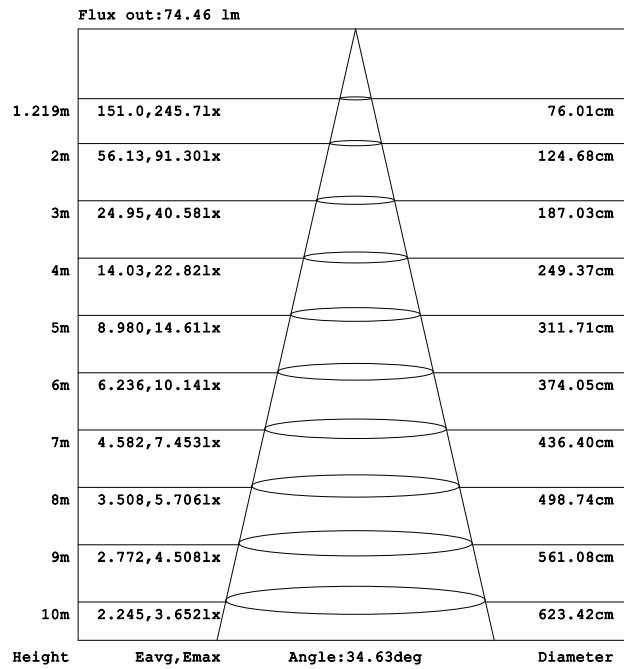

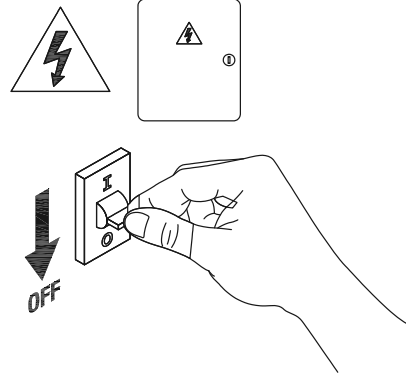
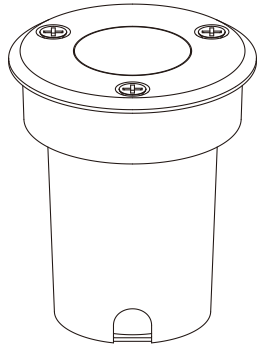

1

Turn off The Power

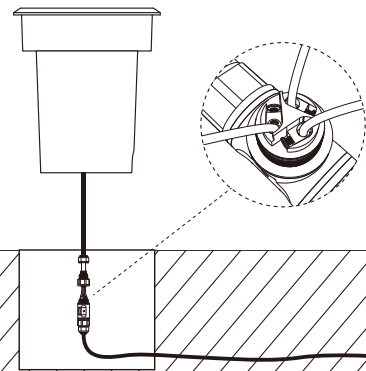
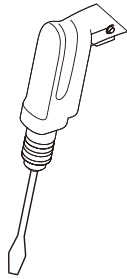

2

Opening holes on the ground

3

Connect the cable



4

Installation completed

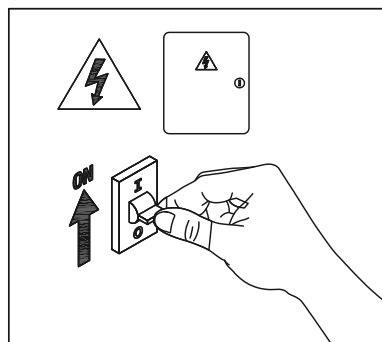

5

Turn on the power

