

## LED Ceiling Lamp

8072

IP65



Item Code	Socket	Dimensions in mm			kg
		A	B	C	
8072	E27*1(Max Size: Ø100mm)	Ø255	350	1000	1.77

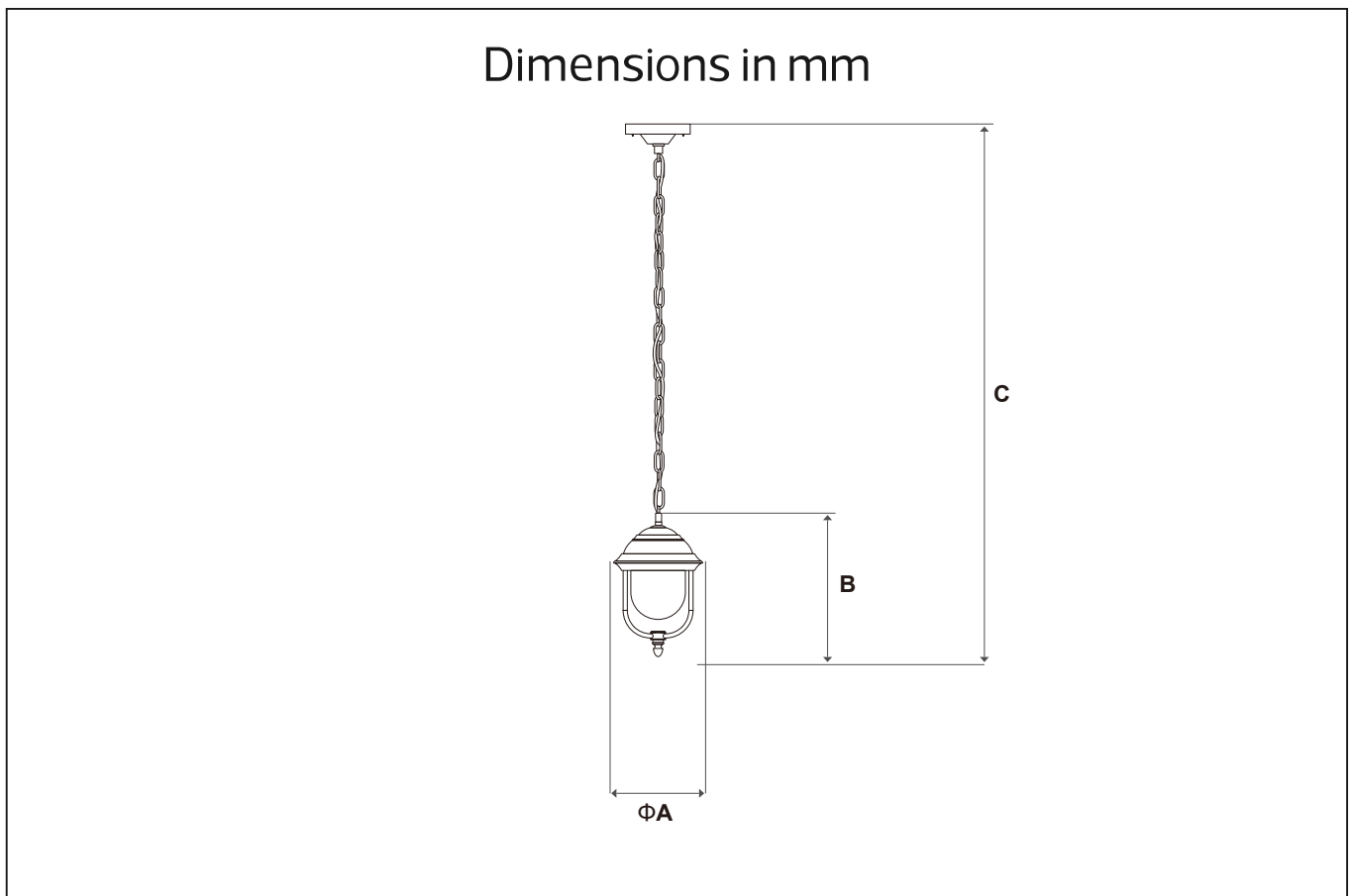





**Description:**  
LED Ceiling Lamp

**Main material:**  
Die-cast aluminum+ glass

**Specification**  
Stable lamp body under stress, Die cast aluminum molding, antioxidant, High transmittance of 98%, beautiful and practical, detachable IP 65

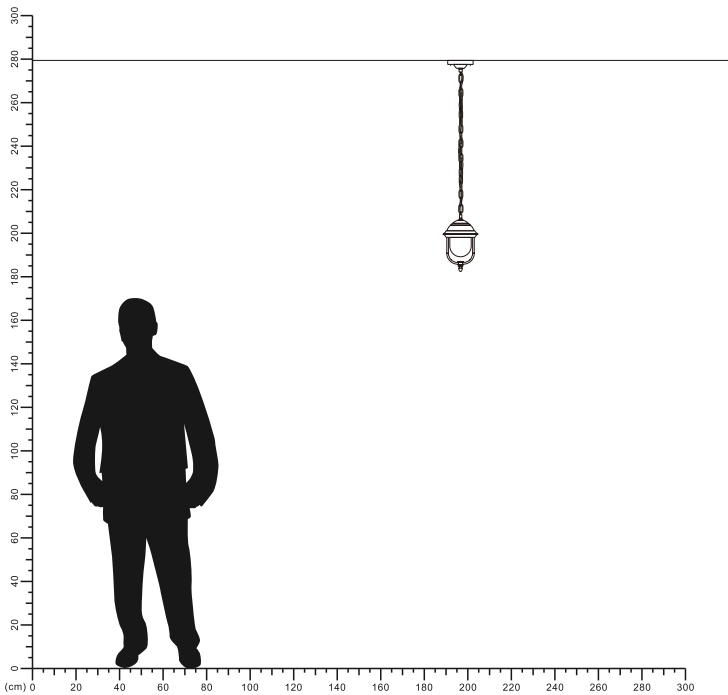
**Applications**  
. Villas  
. Parks  
. Communities

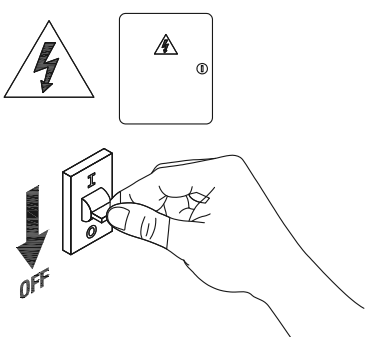
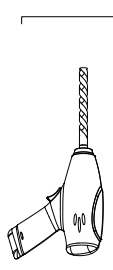
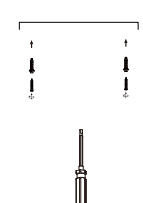
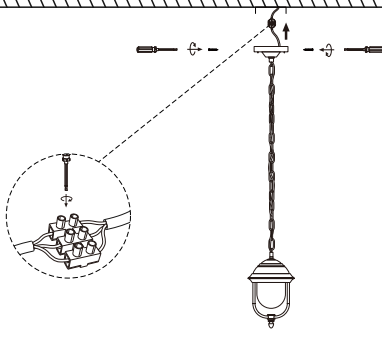
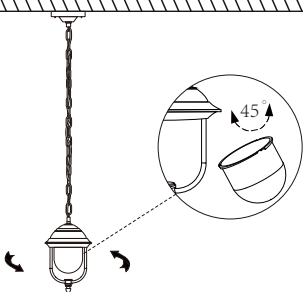
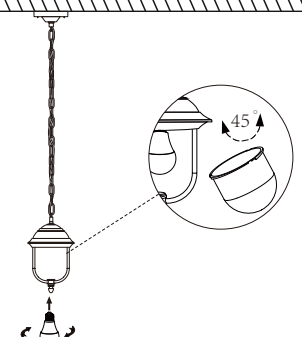

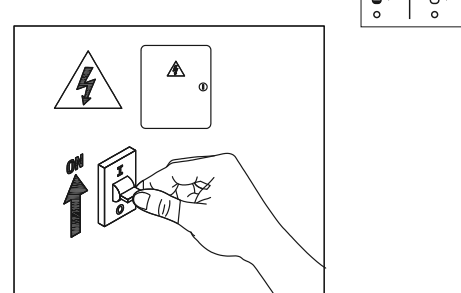
 <p><b>1</b> Turn off The Power</p>	 <p><b>1</b> Drill 2 holes on your ceiling</p>
 <p><b>2</b> Install base plate</p>	 <p><b>3</b> connect the cable and Install the ceiling lamp on the base plate</p>
 <p><b>4</b> Remove the lampshade</p>	 <p><b>5</b> Install E27 lamp and lampshade</p>
 <p><b>6</b> Installation completed</p>	 <p><b>7</b> Turn on the power</p>

