

Lamp Accessories

9048

IP65



Item Code	Socket	Dimensions in mm			kg
		A	B	C	
9048	E27*1(Max Size: Ø100mm)	165	193	310	1.77

Dimensions in mm

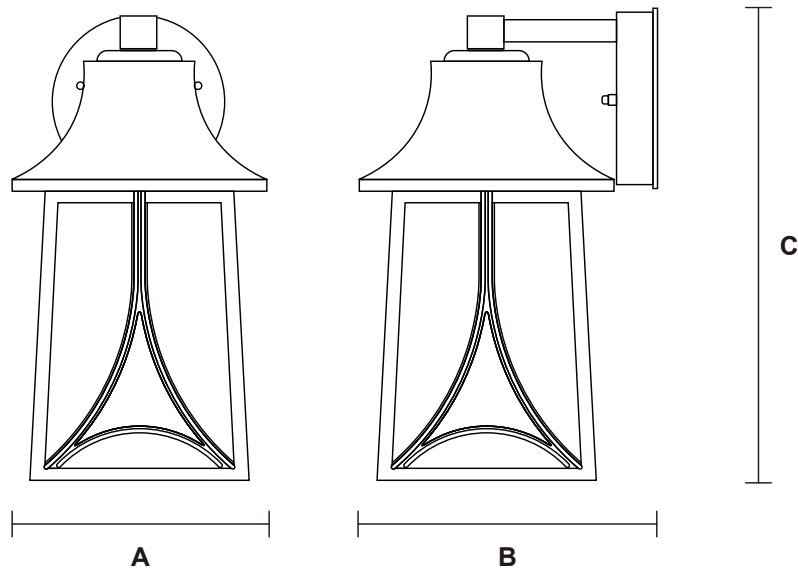

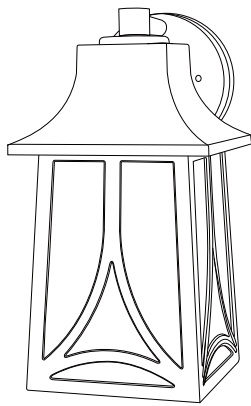

Description:
Lamp Accessories

Main material:
Die-cast aluminum+ Transparent glass

Specification
Stable lamp body under stress, Die cast aluminum molding, antioxidant, High transmittance of 98%, beautiful and practical, detachable
IP 65

Applications
. Villas
. Parks
. Communities

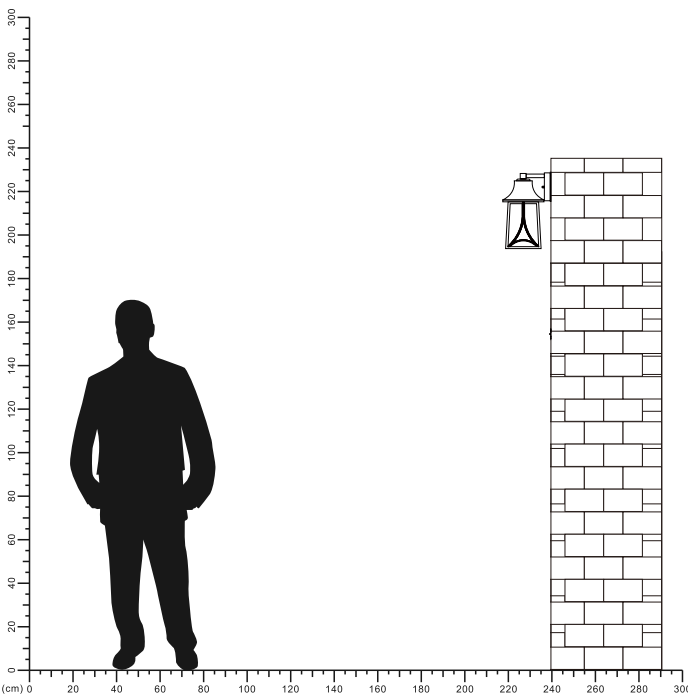

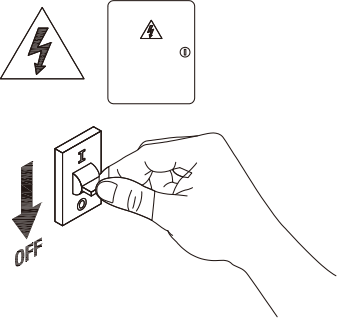
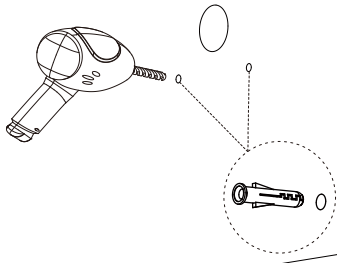
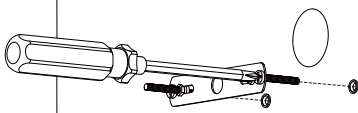
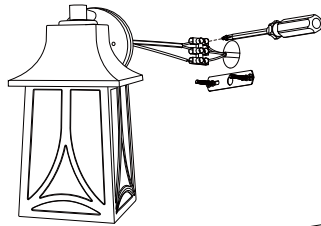
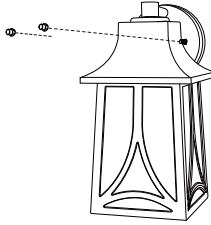
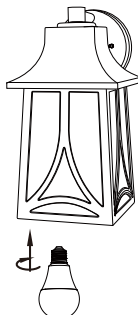
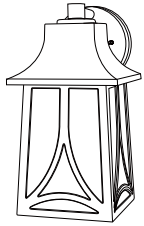
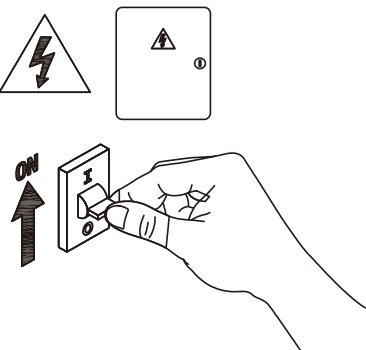
 <p>1 Turn off the power</p>	 <p>2 Drill holes in the wall insert expansion screws</p>
 <p>3 To install the hanging board</p>	 <p>4 Connecting the power cord</p>
 <p>5 Tighten the screw cap</p>	 <p>6 Installing E27 Lamp</p>
 <p>7 Installation completed</p>	 <p>8 Turn on power</p>

