

Lamp Accessories

A092-W
IP65

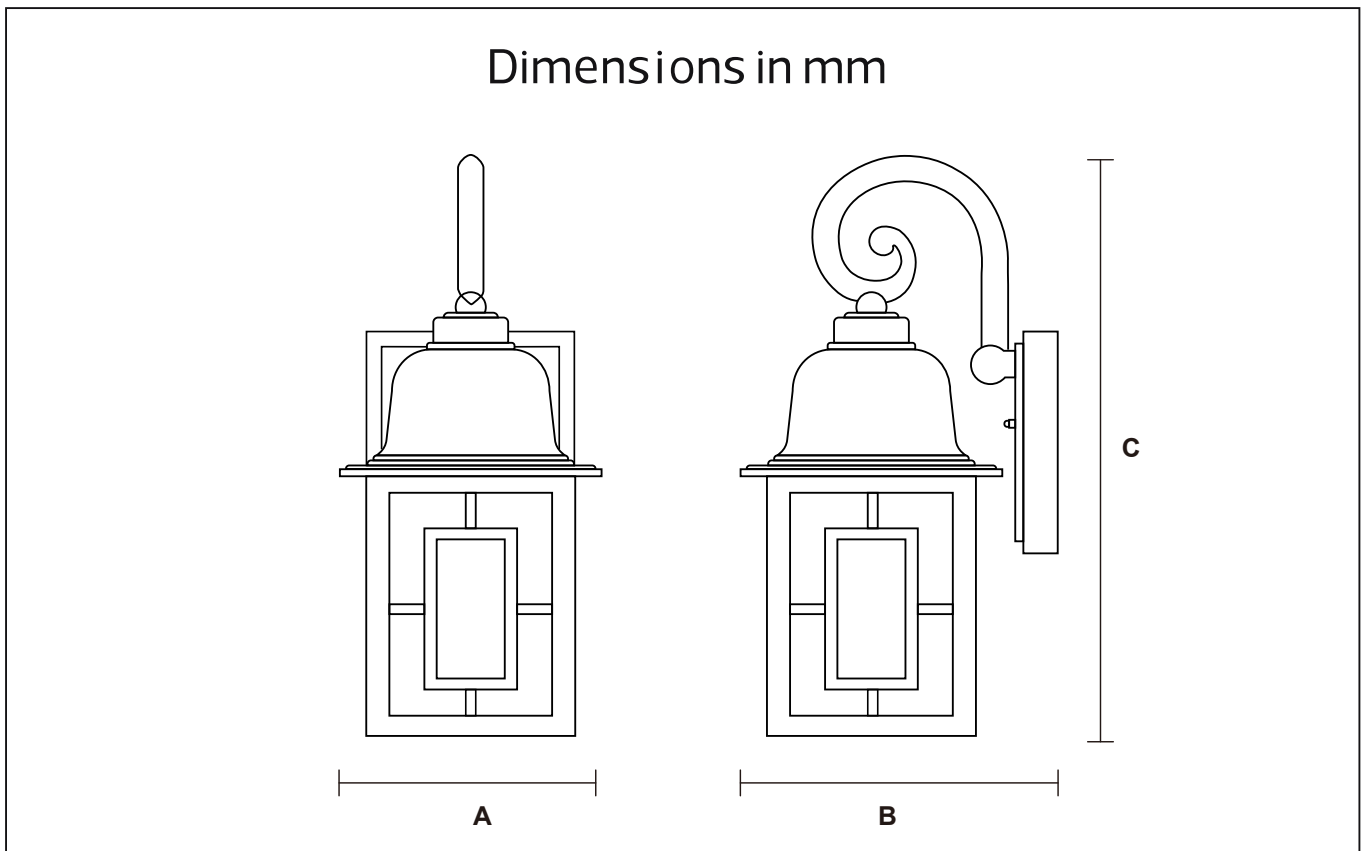

Item Code	Socket	Dimensions in mm			kg
		A	B	C	
A092-W	E27*1(Max Size: Ø100mm)	150	180	340	1.29



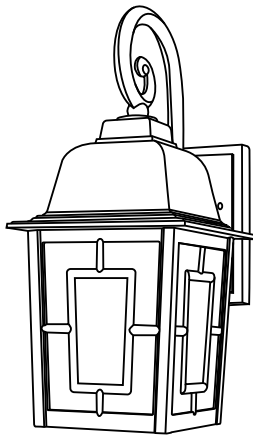
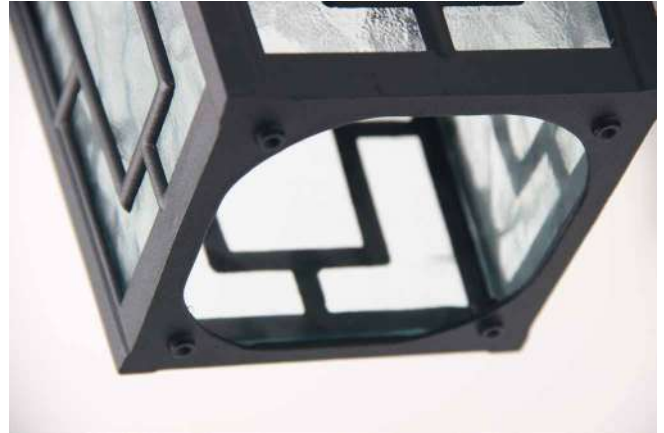

Description:
Lamp Accessories

Main material:
Die-cast aluminum+ Transparent glass

Specification
Stable lamp body under stress, Die cast aluminum molding, antioxidant, High transmittance of 98%, beautiful and practical, detachable
IP 65

Applications
. Villas
. Parks
. Communities

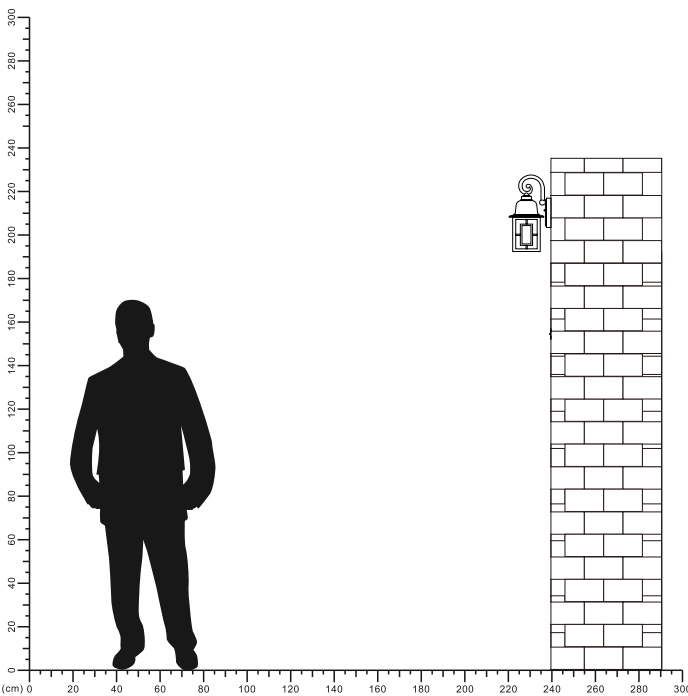

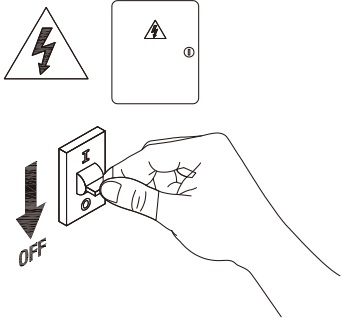

1

Turn off the power

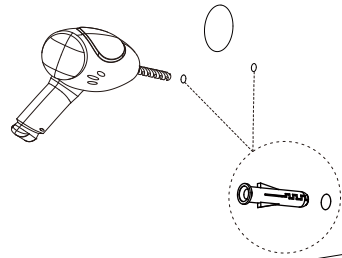

2

Drill holes in the wall insert expansion screws

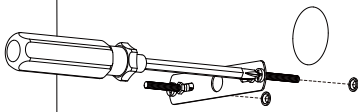

3

To install the hanging board

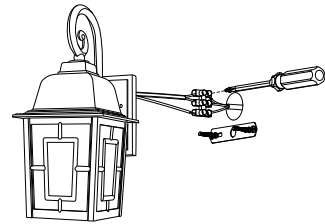

4

Connecting the power cord

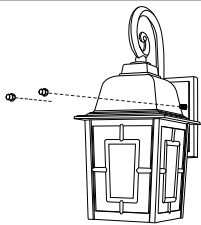

5

Tighten the screw cap

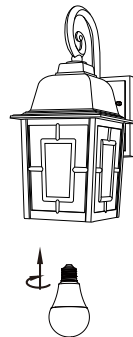

6

Installing E27 Lamp

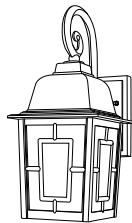

7

Installation completed

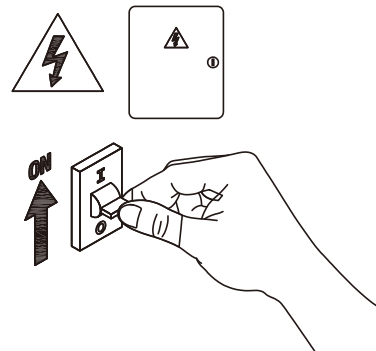

8

Turn on power

