

LED Ceiling Lamp

A093-D

IP65

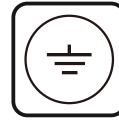

Item Code	Socket	Dimensions in mm			kg
		A	B	C	
A093-D	E27*1(Max Size: Ø85mm)	□152	290	1000	1.4

Dimensions in mm

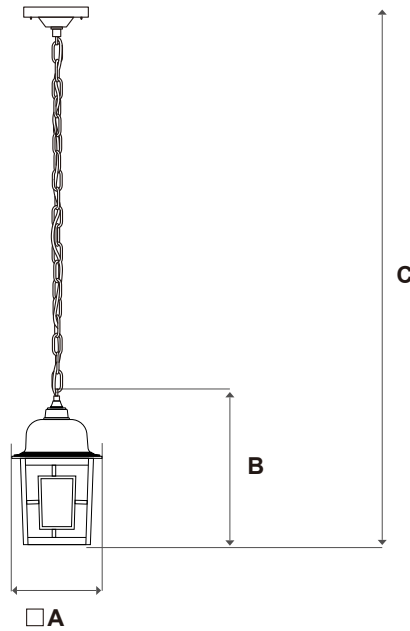

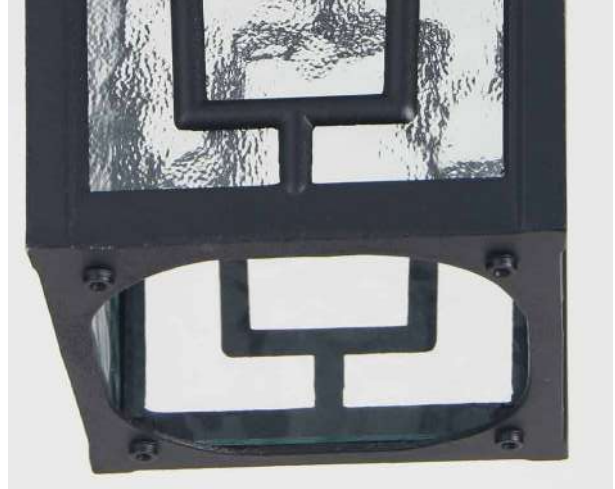

Description:

LED Ceiling Lamp

Main material:

Die-cast aluminum+ glass

Specification

Stable lamp body under stress, Die cast aluminum molding, antioxidant, High transmittance of 98%, beautiful and practical, detachable IP 65

Applications

- . Villas
- . Parks
- . Communities

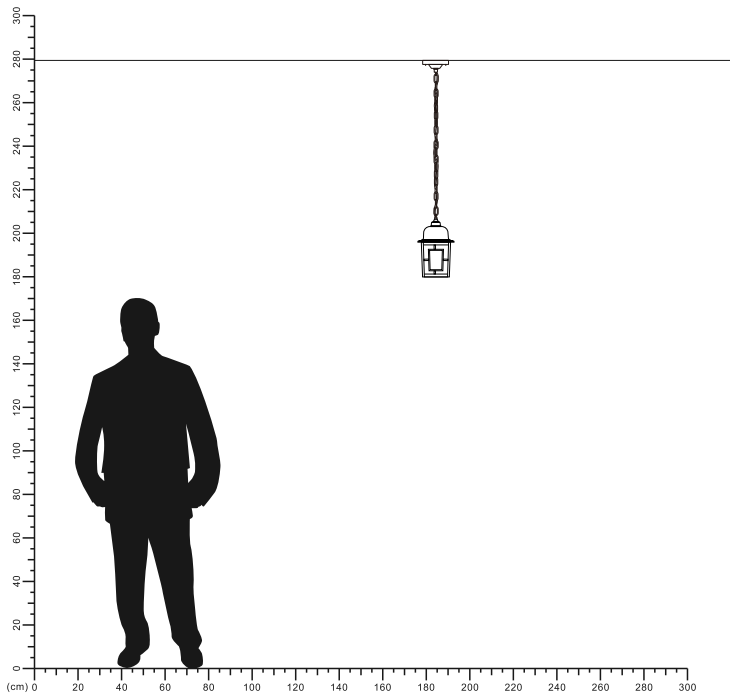

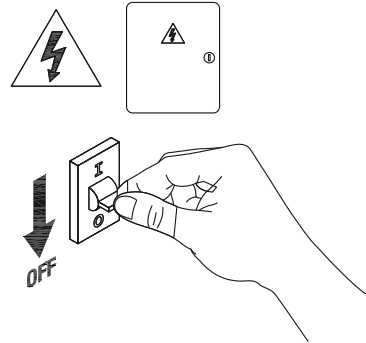

1

Turn off The Power

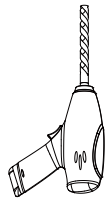

2

Drill 2 holes on your ceiling



3

Install base plate

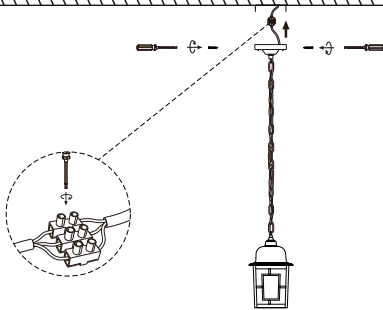

4

connect the cable and
Install the ceiling lamp on the base plate



5

Install E27 bulb



6

Installation completed

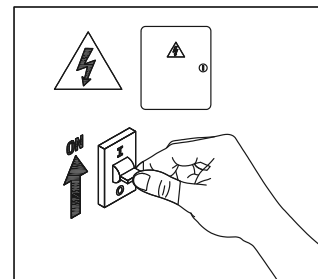

7

Turn on the power

