

Lamp Accessories

A093
IP65



Item Code	Socket	Dimensions in mm			kg
		A	B	C	
A093	E27*1(Max Size Φ 95mm)	152	187	345	1.2

Dimensions in mm

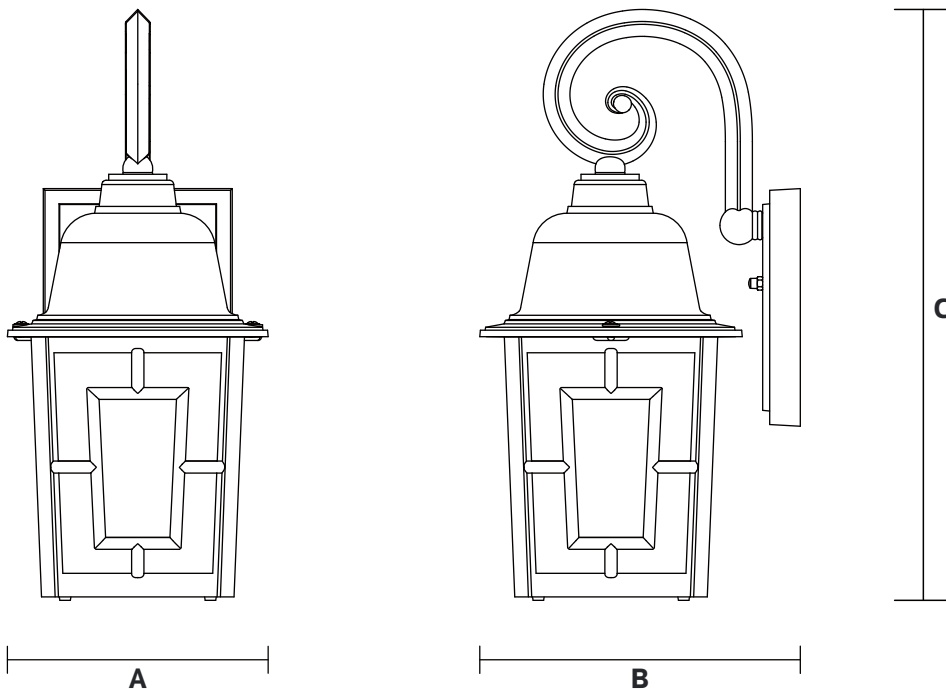

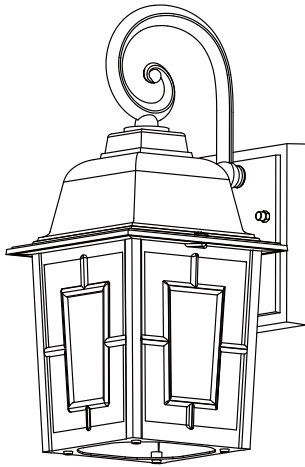
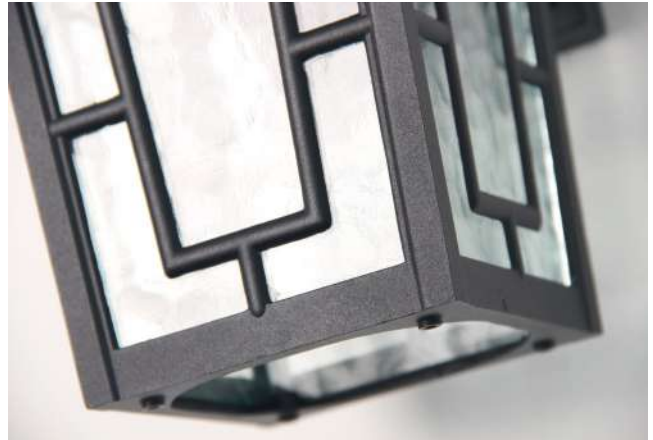

Description:
Lamp Accessories

Main material:
Die-cast aluminum lamp body+glass lamp shade

Specification
Durable lamp body, integrated die-casting forming, with a hard texture but wear resistance. The lampshade has clear light transmission, and the light effect is soft without dark areas. IP65

Applications

- . Suitable for villa
- . Courtyard
- . Community
- . Balcony
- . Garden path

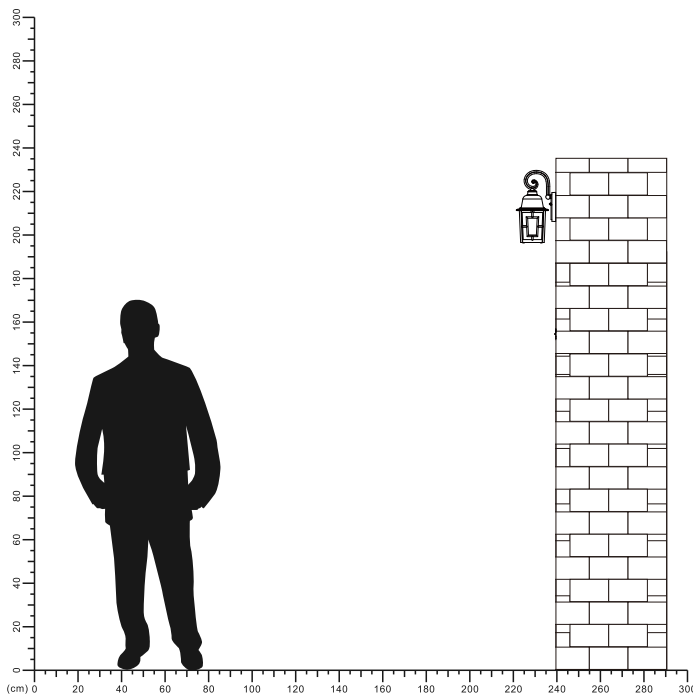

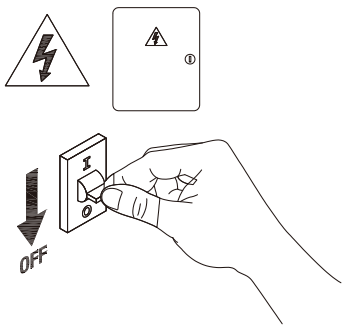
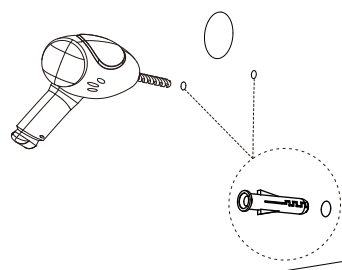
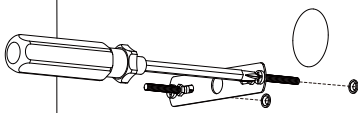
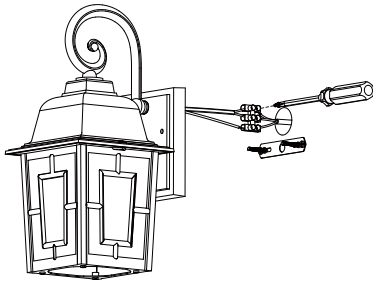
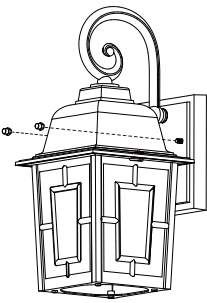
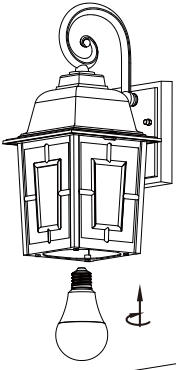
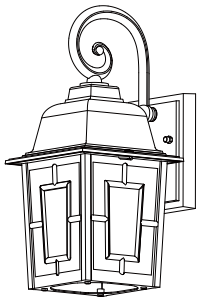
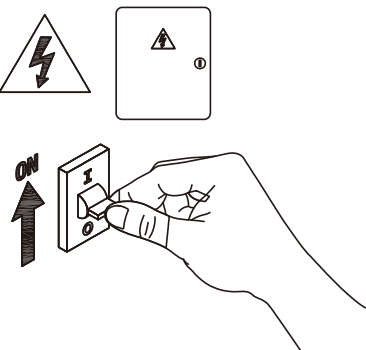
 <p>1 Turn off the power</p>	 <p>2 Drill holes in the wall insert expansion screws</p>
 <p>3 To install the hanging board</p>	 <p>4 Connecting the power cord</p>
 <p>5 Tighten the screw cap</p>	 <p>6 Tighten the bulb</p>
 <p>7 Installation completed</p>	 <p>8 Turn on power</p>

