

LED Floor Lamp

FL-1118

IP20



Item Code	Socket	Color	kg
FL-1118	E27*2	Black	23

On/Off switching dimming function depending on the installed E27 light source

Dimensions in mm

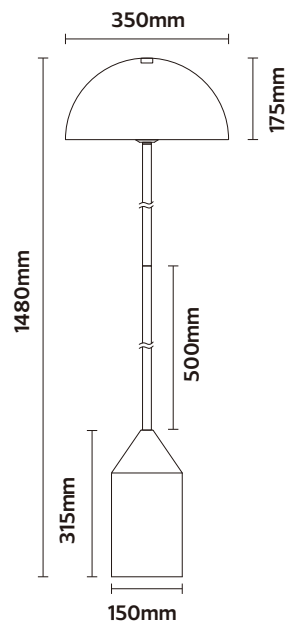

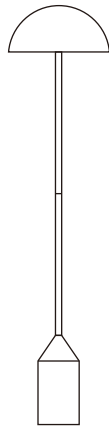

Description:
LED Floor Lamp

Main material:
Iron

Specification

Special tree branch shape appearance, simple but full of personality and creative, randomly match the scene.
IP20

Applications

- . Hotel
- . Hall
- . Room

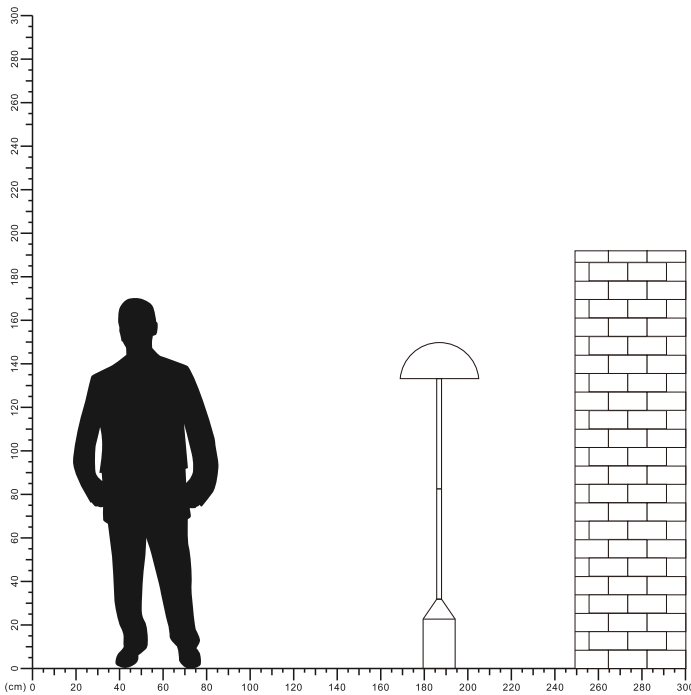

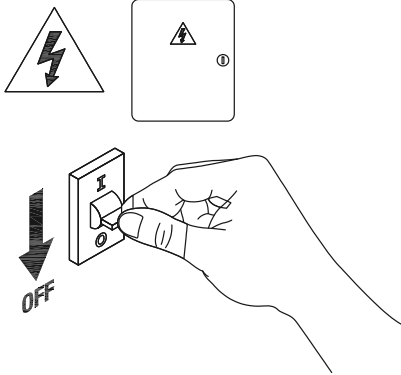

1

Turn off The Power

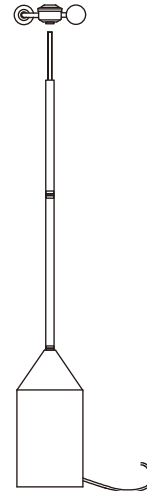

2

Install E27 lamp holder

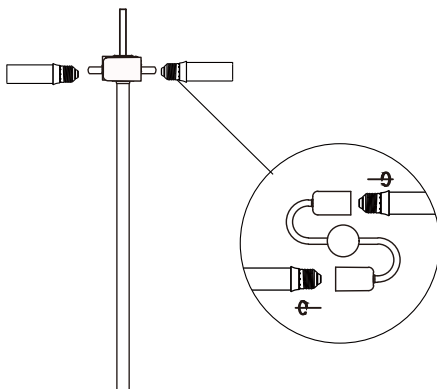

3

Installing E27 bulb

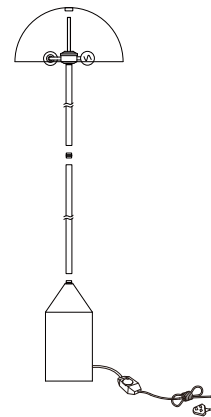

4

Install lampshade and lamp post

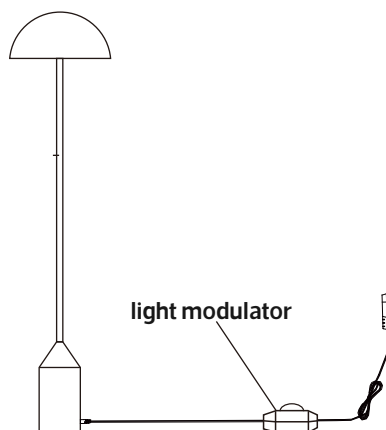

5

Installation completed

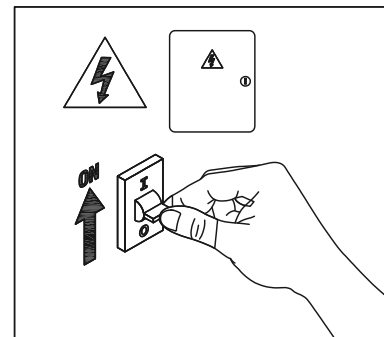

6

Turn on the power

