

LED Outdoor Wall Lamp

HJ-W815

IP65

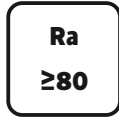

Item Code	P(W)	CCT(K)	Total Lumen	Beam Angle	Dimensions in mm			kg
					A	B	C	
HJ-W815	6	6500/4000/3000	270	90°	90	55	160	0.45

Dimensions in mm

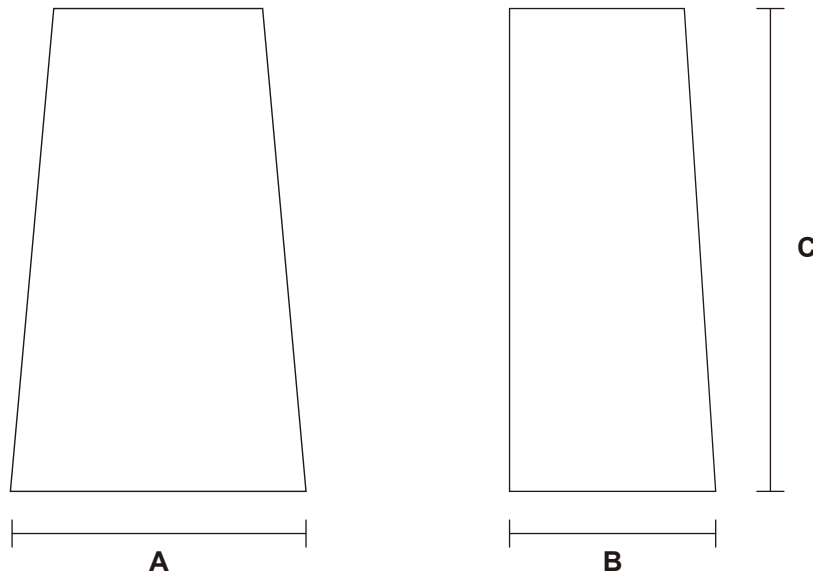



High bright LED chip, stable and durable light



Surface dusting treatment, beautiful and generous

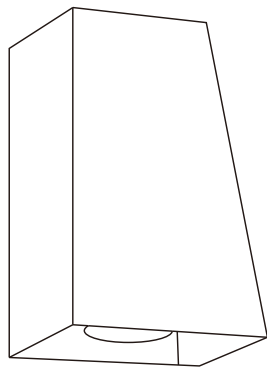

Description:
LED Outdoor Wall Lamp

Main material:
Aluminum+Glass

Specification
Energy saving, up to 85% energy saving comparing to standard halogen and incandescent lamps
High quality light, high color rendering, less heat, no UV or IR radiation
Build-in LED Driver
IP65

Applications

- . Park
- . Square
- . Tourist attraction
- . Corridor

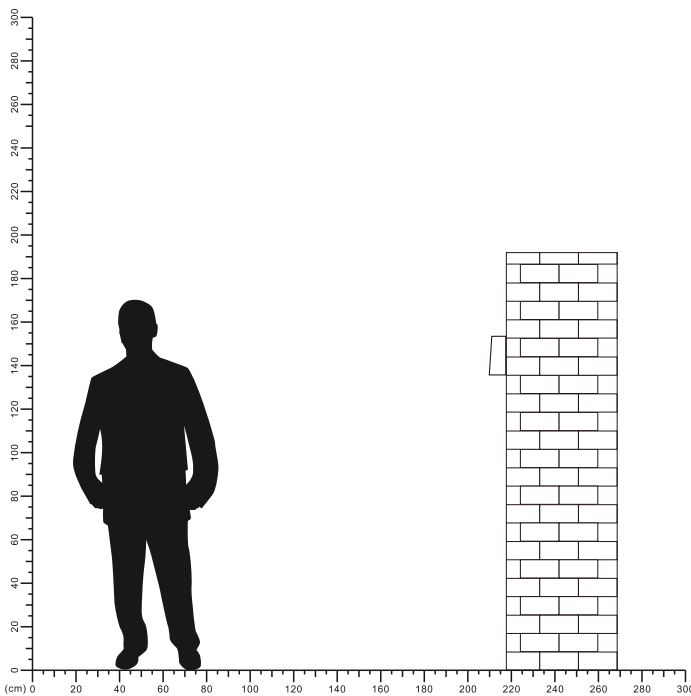

LUMINOUS INTENSITY DISTRIBUTION DIAGRAM

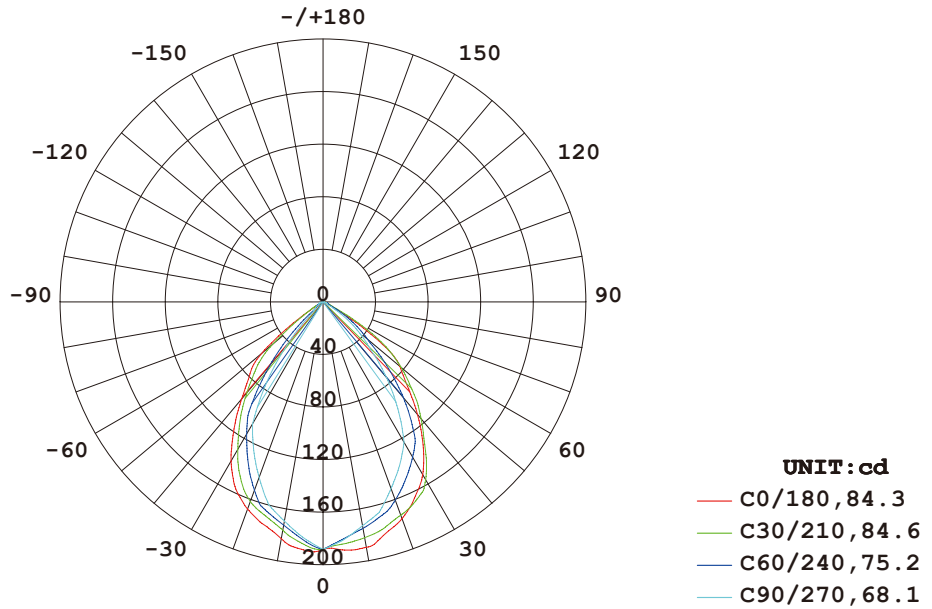

AVERAGE BEAM ANGLE (50%) : 78.0 DEG

Illuminance at a Distance

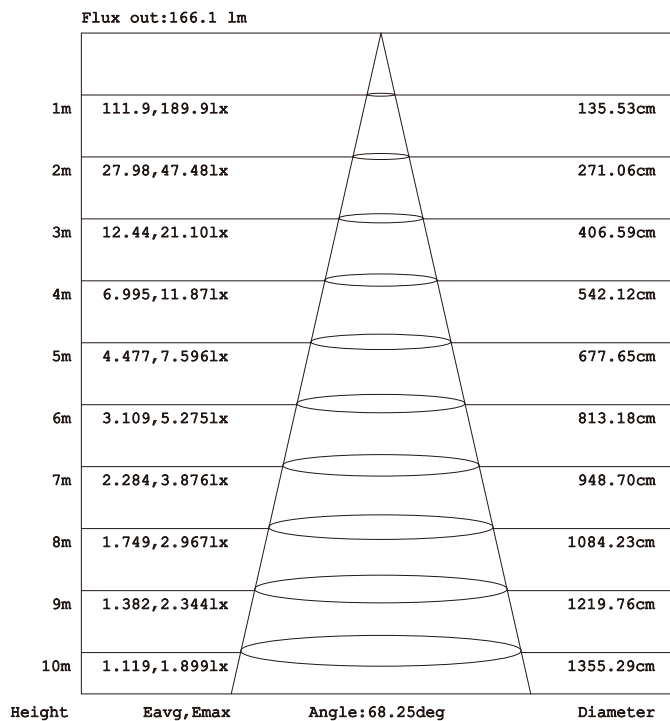

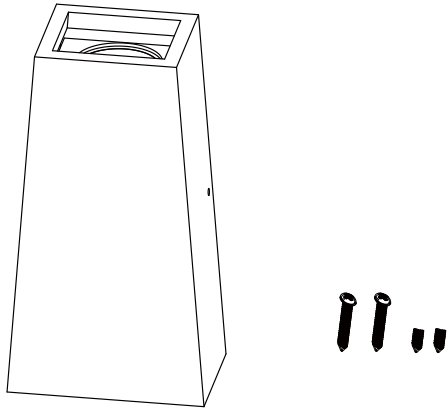

1

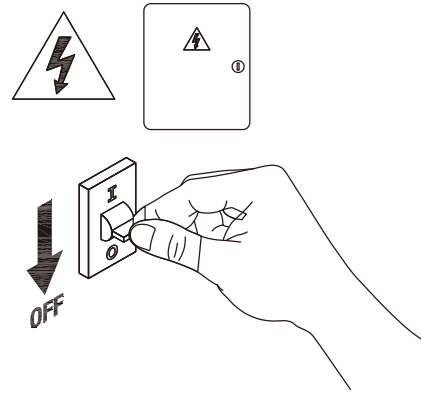

2

Turn off The Power

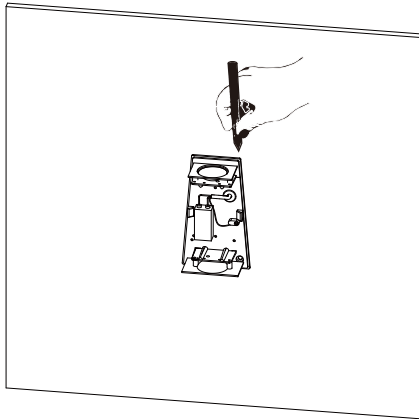

3

Draw the points that need to be drilled

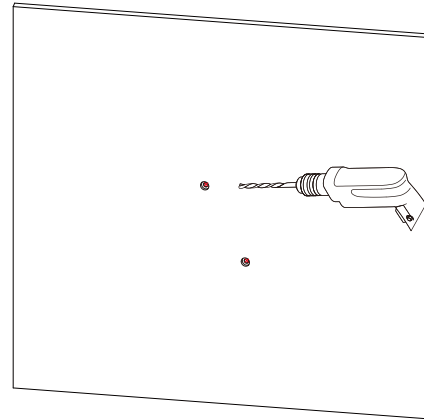

4

Cut a hole on your wall

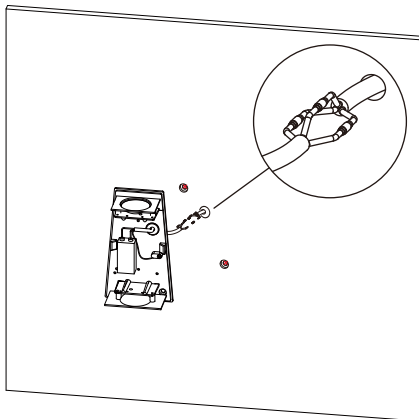

5

Install screws and connect cables

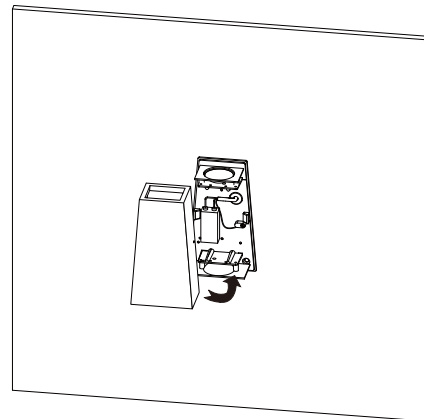

6

Installation of the shell

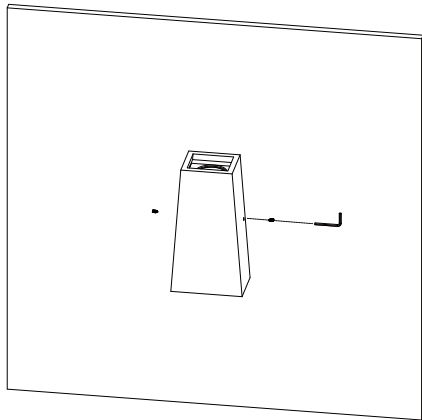

7

Install screws

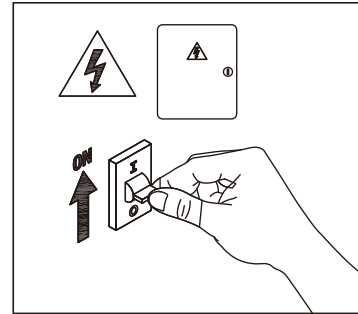

8

Turn on the power

