

## LED Outdoor Wall Lamp

HL-8101-BK  
IP65

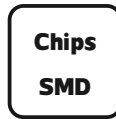
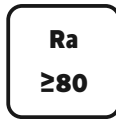

Item Code	P (W)	CCT(K)	Color	Beam angle	Output (lm)	lm/w	Hole Size (mm)	Dimensions in mm			kg
								A	B	C	
HL-8101-BK	3	3000	Black	36°	30	10	50x100	60	52	210	0.275

### Dimensions in mm

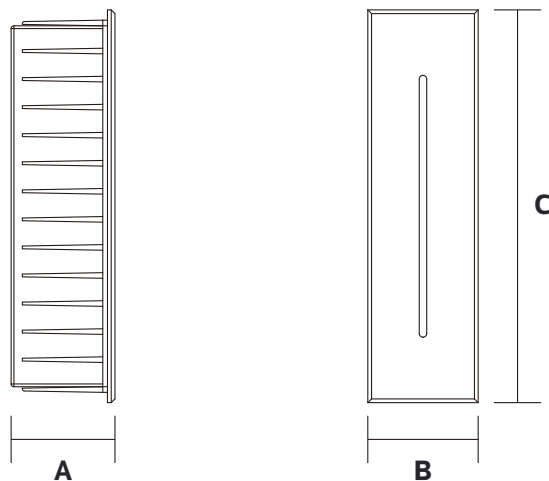

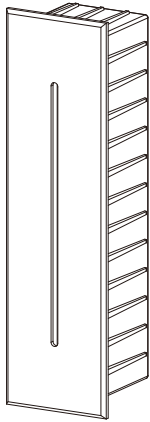

**Description:**  
LED Outdoor Wall Lamp

**Main material:**  
Aluminum+Engineering plastics

**Specification**  
Energy saving, up to 85% energy saving comparing to standard halogen and incandescent lamps  
High quality light, high color rendering, less heat, no UV or IR radiation  
Build-in LED Driver  
IP65

**Applications**  

- . Park
- . Square
- . Tourist attraction
- . Corridor

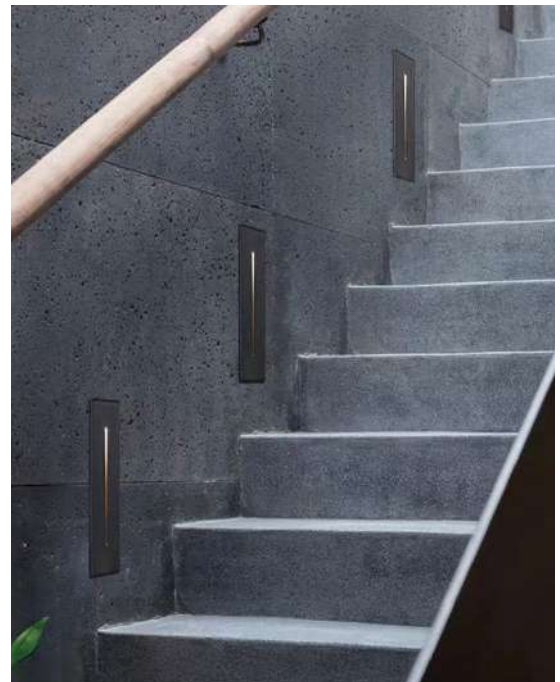
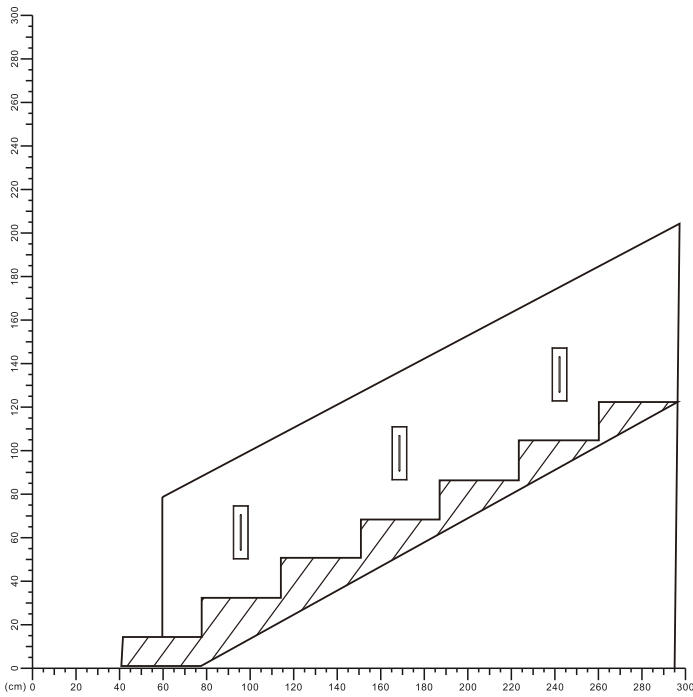

# LUMINOUS INTENSITY DISTRIBUTION DIAGRAM

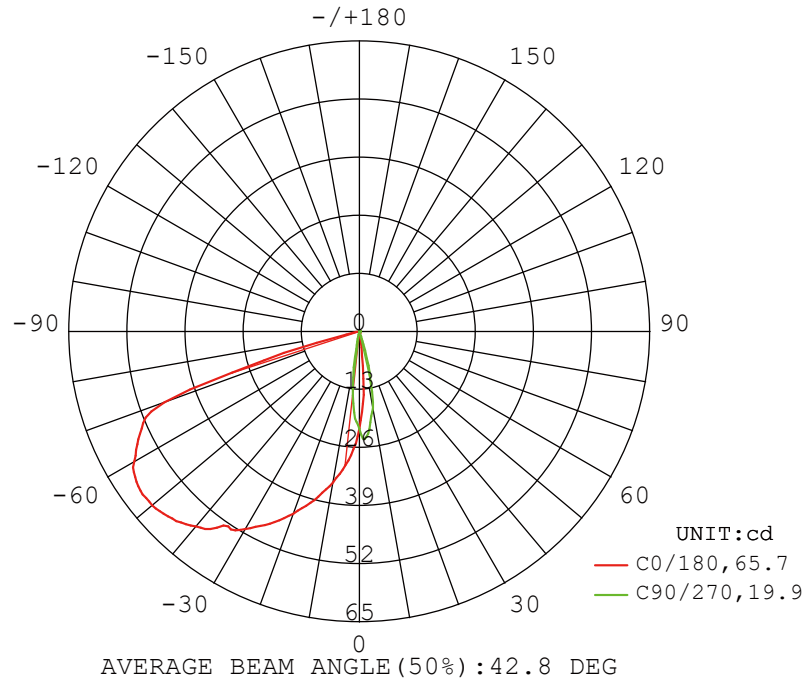

## Illuminance at a Distance

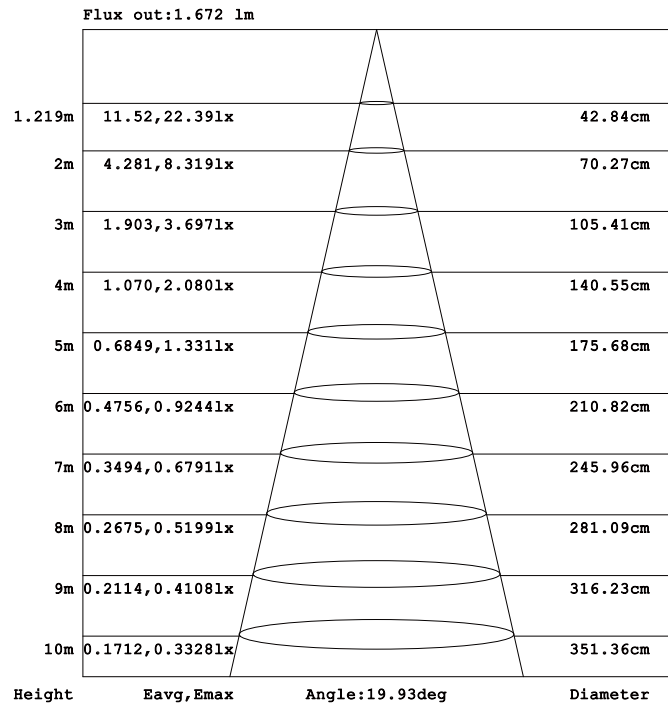

Note: The Curves indicate the illuminated area and the average illumination when the luminaire is at different distance.

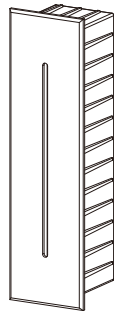

**1**

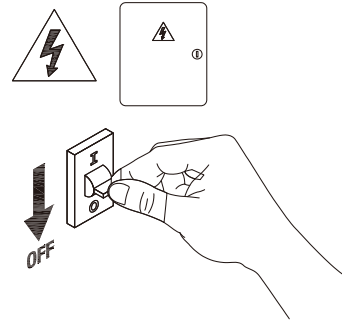

**2**

**Turn off the power**

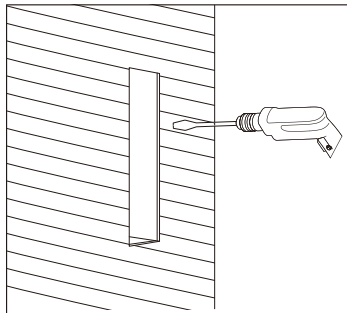

**3**

**Drill a holes on your wall**

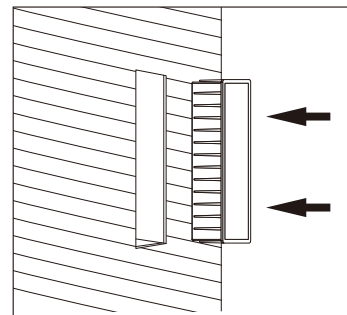

**4**

**Fixing the base box**

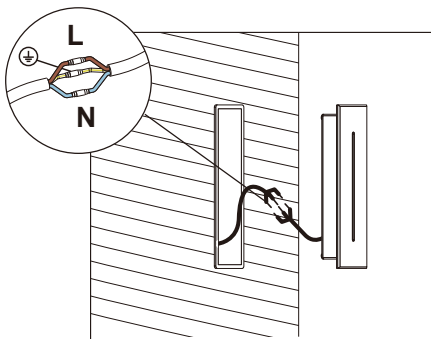

**5**

**Connect the cable**

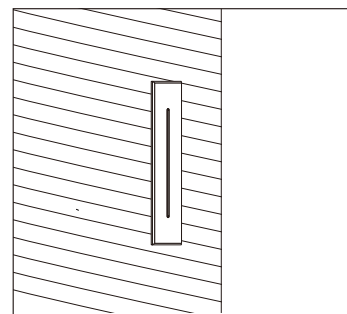

**6**

**Installation completed**

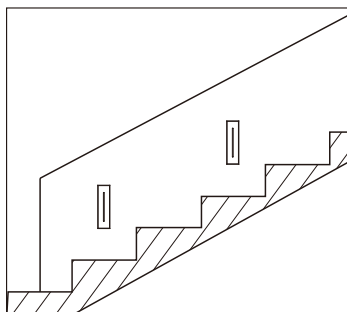

**7**

**Installation completed**

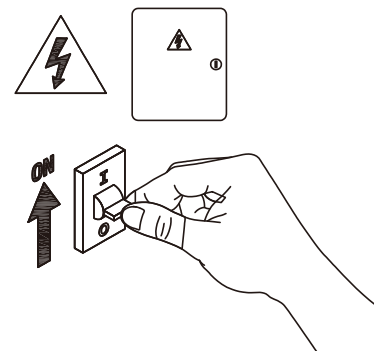

**8**

**Turn on power**

