

LED OUTDOOR BURIED LAMP

HL1055 Series
IP65

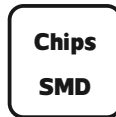
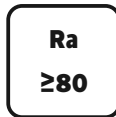

Item Code	P (W)	CCT (K)	Beam angle	Output (lm)	lm/w	Dimensions in mm		kg
						A	B	
HL7055	3	3000	120°	50	16.6	□70	50	0.15
HL1055	4	3000	120°	66.4	16.6	□105	54	0.27

Dimensions in mm

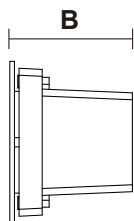
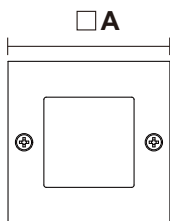

Item Code:HL7055

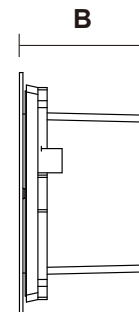
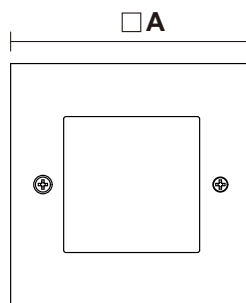

Item Code:HL1055

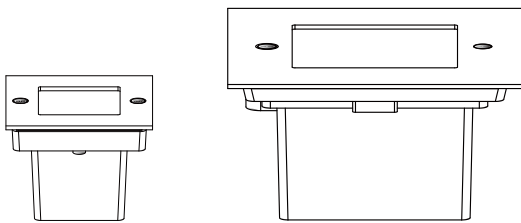
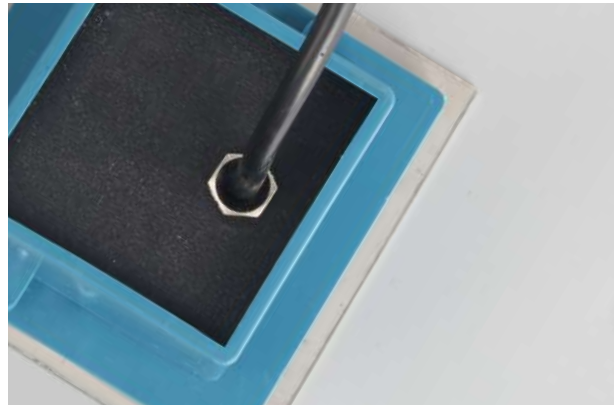

Description:
LED OUTDOOR BURIED LAMP

Main material:
Aluminum+Engineering plastics

Specification
Energy saving, up to 85% energy saving comparing to standard halogen and incandescent lamps
High quality light, high color rendering, less heat, no UV or IR radiation
Build-in LED Driver
IP65

Applications

- . Park
- . Square
- . Tourist attraction
- . Corridor

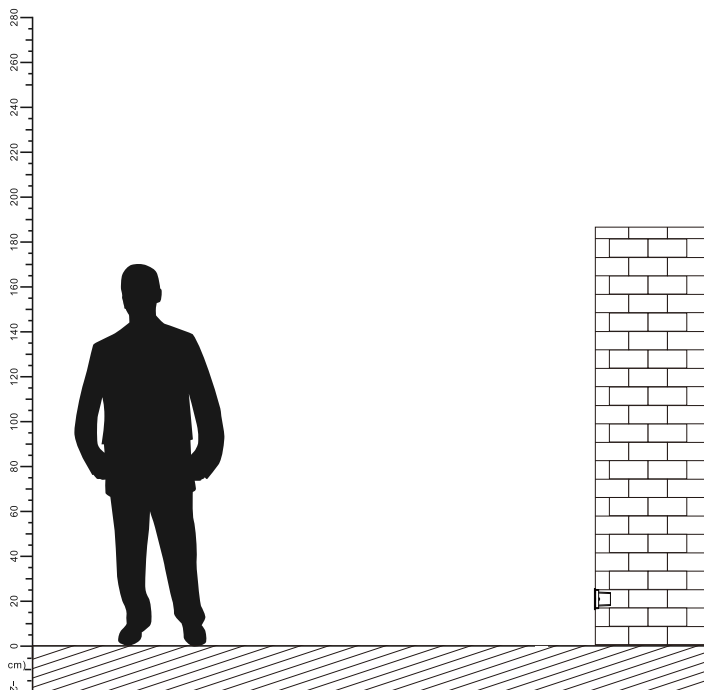

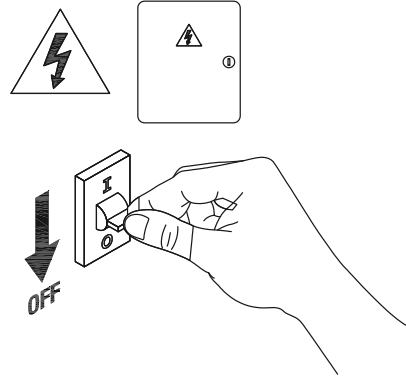
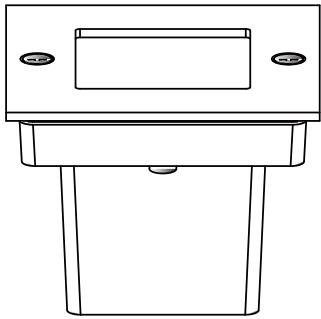

1

Turn off The Power

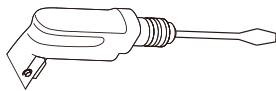

2

Opening holes in the wall

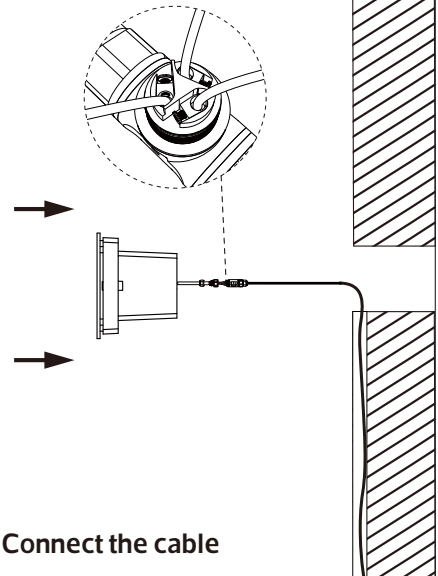

3

Connect the cable



4

Installation completed

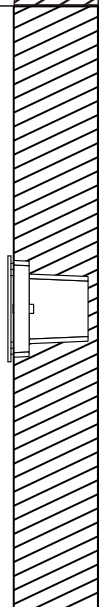

5

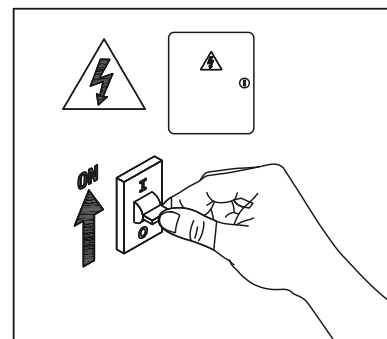

Turn on the power

