

## HV- CL101S Series

### LED Surface Downlight



<b>Indoor</b> 	<b>AC</b> 220-240V	<b>50/60</b> Hz	<b>PF</b> ≥0.9	<b>CCT</b> 6500K 4000K 3000K	<b>Ra</b> ≥80	<b>IP20</b>	<b>Beam Angel</b> 90°/120°	<b>Chips</b> SMD	
-------------------	-----------------------	--------------------	-------------------	---------------------------------------	------------------	-------------	-------------------------------	---------------------	--

Item Code	P (W)	CCT(K)	Beam angle	Output (lm)	lm/w	A	B	
HV-CL101S-15	15	6500/4000/3000	90°	1200	80	168	42	0.26
HV-CL101S-24	24	6500/4000/3000	120°	1920	80	220	42	0.49
HV-CL101S-30	30	6500/4000/3000	120°	2400	80	220	42	0.51
HV-CL101S-40	40	6500/4000/3000	120°	3200	80	310	42	0.73

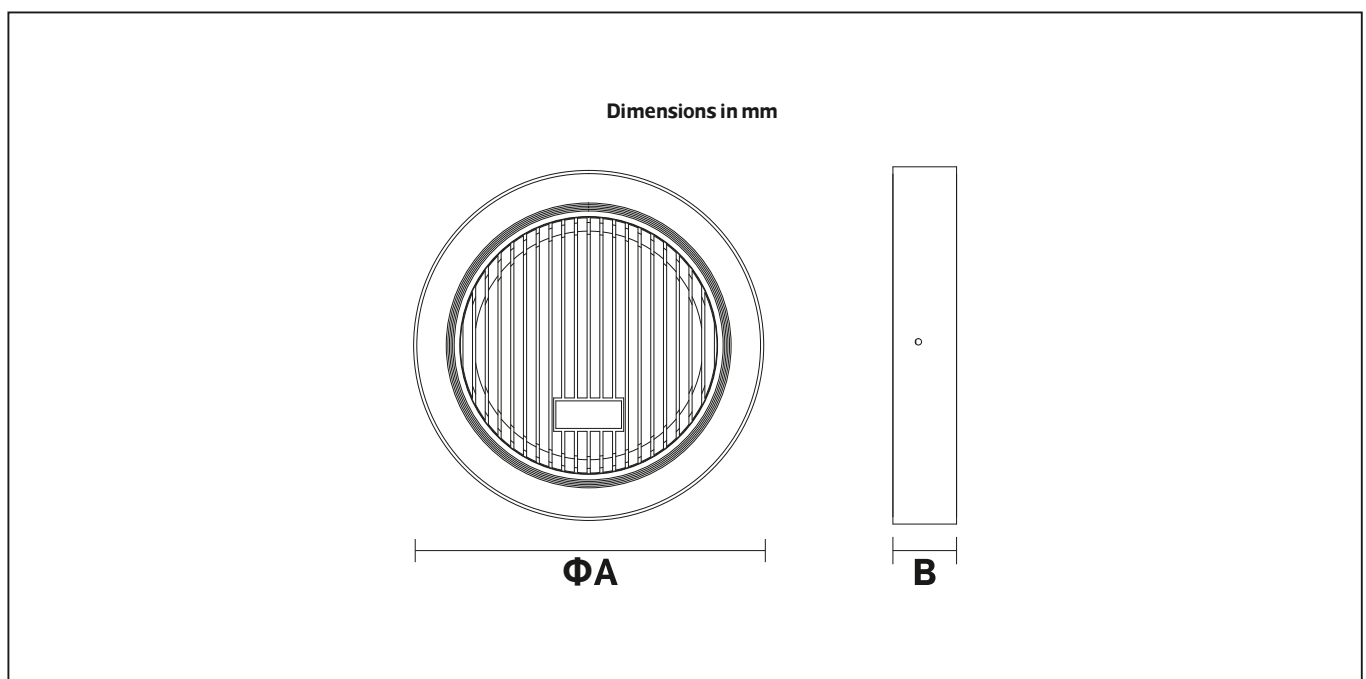



Surface design, no need drill a hole

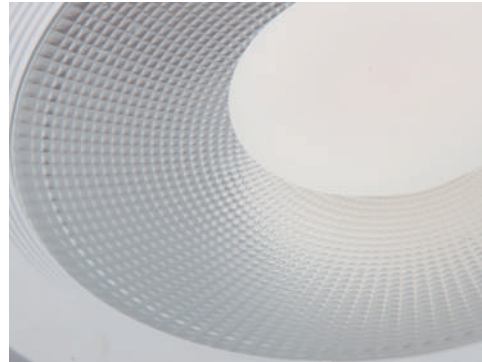

Anti-dazzle highlight reflector

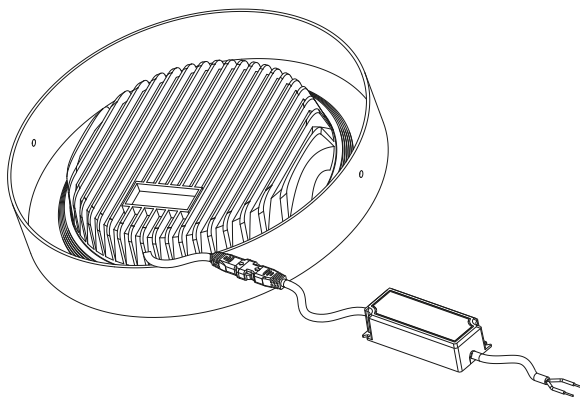

**Description**  
LED Surface Downlight

**Main material**  
Die-cast aluminum + PC Plastic

**Specification**  
Energy saving, up to 85% energy saving comparing to standard halogen and incandescent lamps High quality light, high color rendering, less heat, no UV or IR

**Applications**  
Bedroom  
Sitting room  
Study room  
Corridor

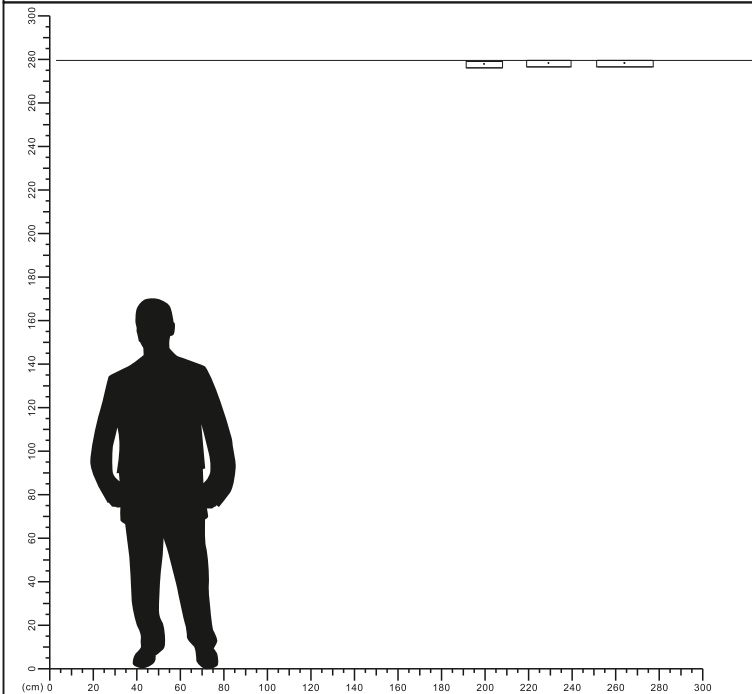

# LUMINOUS INTENSITY DISTRIBUTION DIAGRAM

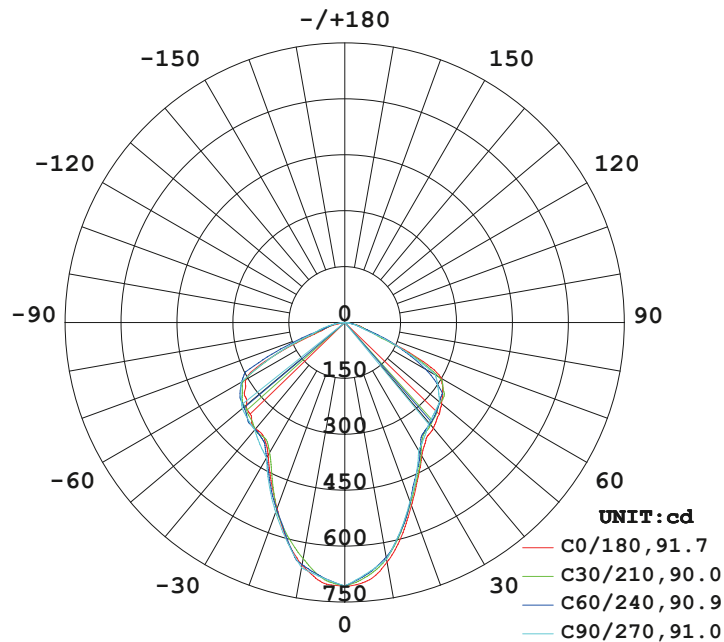

**AVERAGE BEAM ANGLE (50%) : 90.9 DEG**

## Illuminance at a Distance

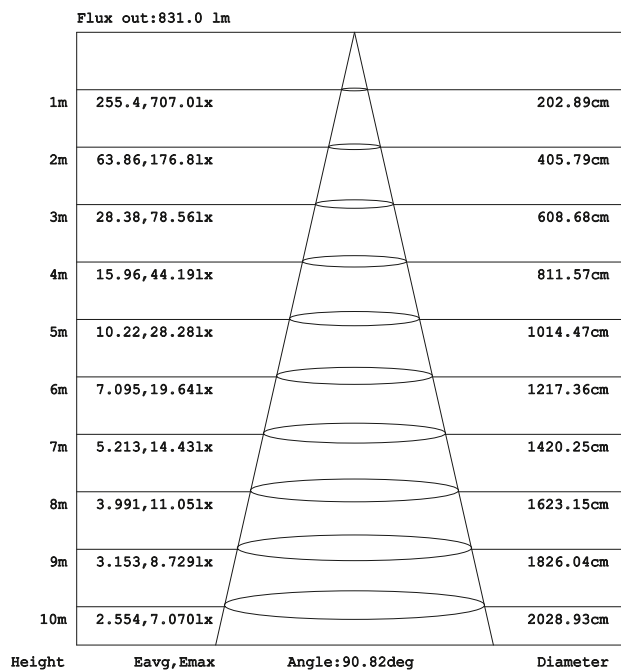

Note: The Curves indicate the illuminated area and the average illumination when the luminaire is at different distance.

**Model: HV-CL101S-15**

# LUMINOUS INTENSITY DISTRIBUTION DIAGRAM

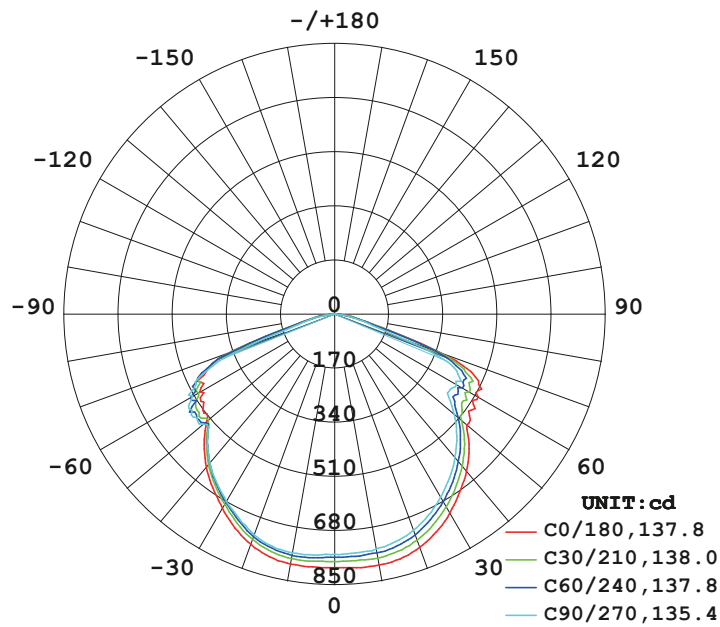

**AVERAGE BEAM ANGLE (50%) : 137.2 DEG**

## Illuminance at a Distance

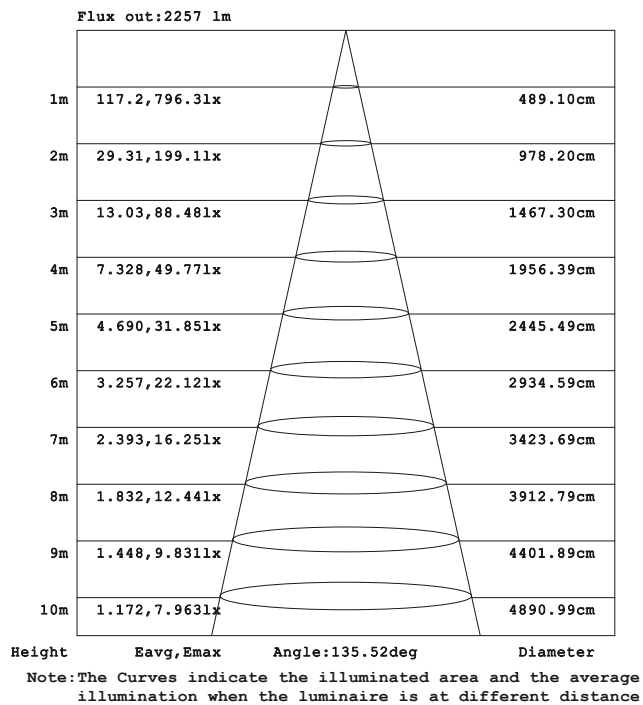

**Model:HV-CL101S-30**

# LUMINOUS INTENSITY DISTRIBUTION DIAGRAM

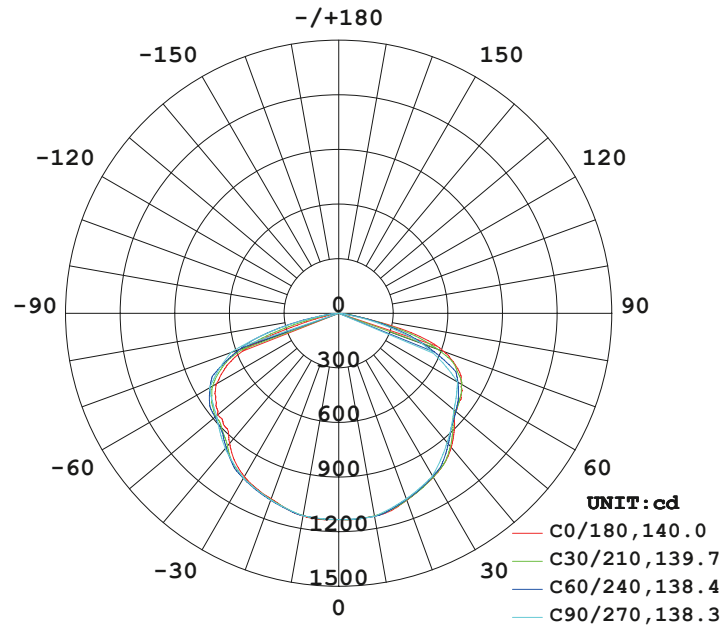



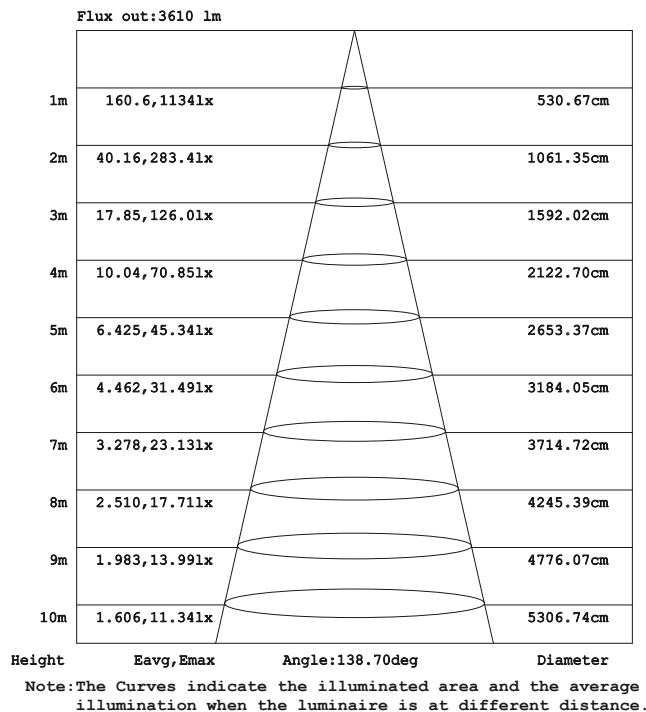

**AVERAGE BEAM ANGLE (50%) : 139.1 DEG**

## Illuminance at a Distance

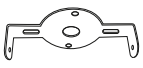
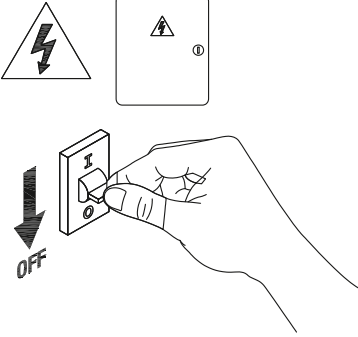

**Model: HV-CL101S-40**

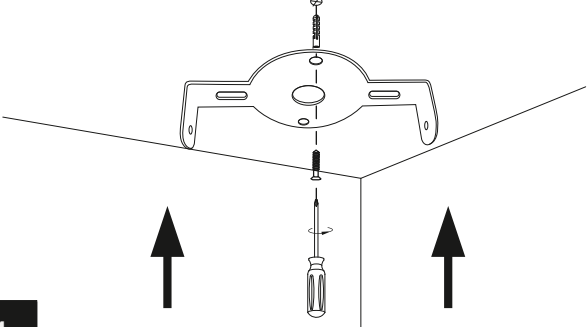
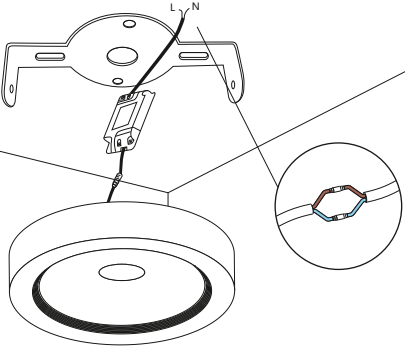
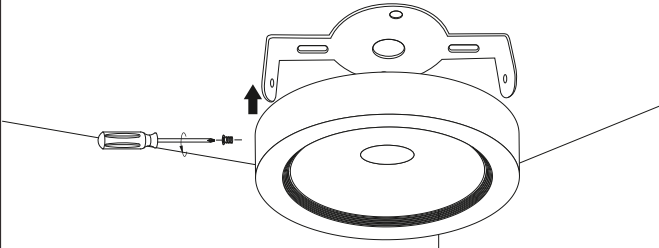
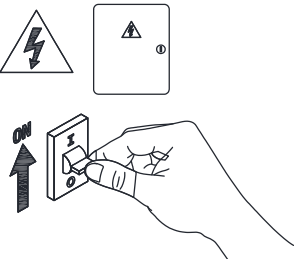
<p><b>1</b></p> <ul style="list-style-type: none"> <li> <b>X 2</b> Plastic expansion screw</li> <li> <b>X 2</b> Screws</li> <li> <b>X 2</b> Screws (on the back of panel)</li> <li> <b>X 1</b> Ceiling Fixed Accessories</li> </ul>	<p><b>2</b></p> <p>Turn off power</p> 
<p><b>3</b></p> 	<p><b>4</b></p> 
<p><b>5</b></p> 	<p><b>6</b></p> 
<p><b>7</b></p> <p>Turn on power</p> 	<p><b>8</b></p> 