

## Lamp Accessories

LH-88051-gold  
IP20

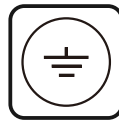

Item Code	Socket	Color	Dimensions in mm			kg
			A	B	C	
LH-88051-gold	E27*2(Max Size:Φ55mm)	Golden	180	90	448	2.5
LH-88051-black	E27*2(Max Size:Φ55mm)	Black	180	90	448	2.5

### Dimensions in mm

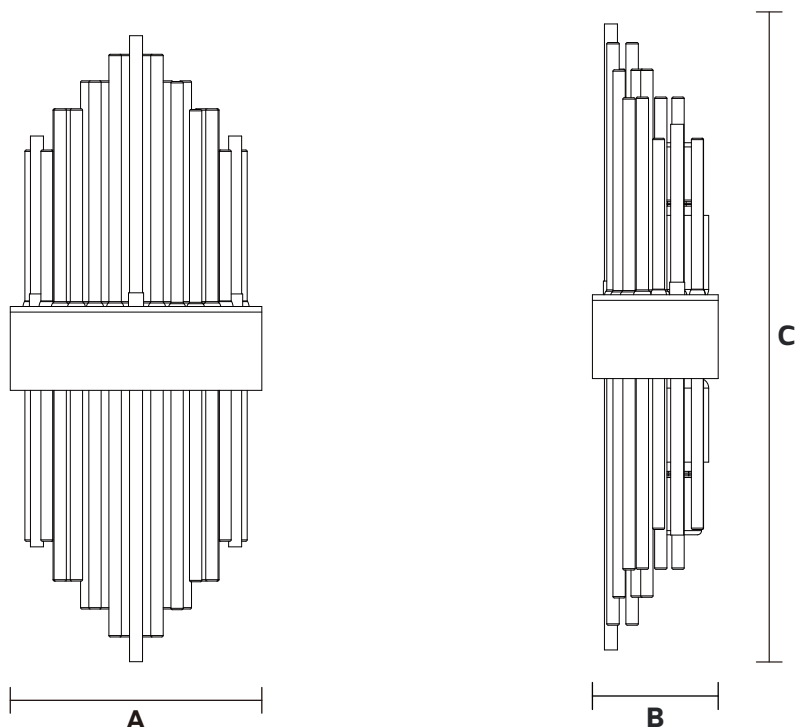

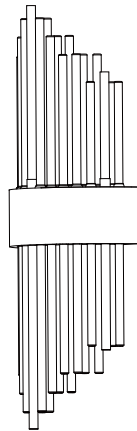
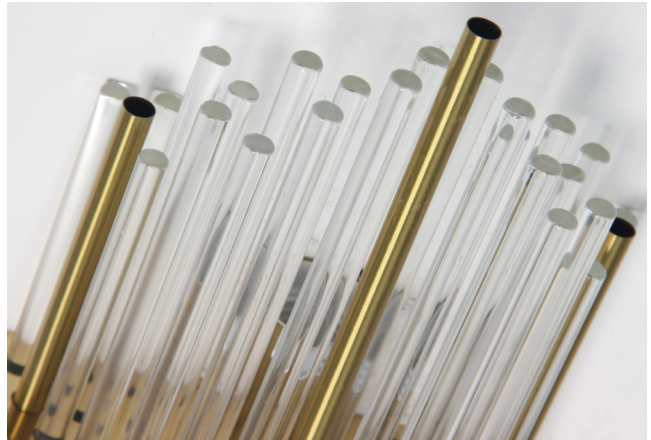

**Description:**  
Lamp Accessories

**Main material:**  
Stainless steel+glass

**Specification**

High strength stainless steel lamp body, with nano polishing and electroplating treatment on the surface, the metal color is full and the surface is bright, attractive and durable  
Selected high-quality glass rods with exquisite and delicate cutting techniques, strong transparency, uniform and non dazzling light, and crystal clear refracted light

IP 20

**Applications**

- . Living room
- . dining room
- . bedroom

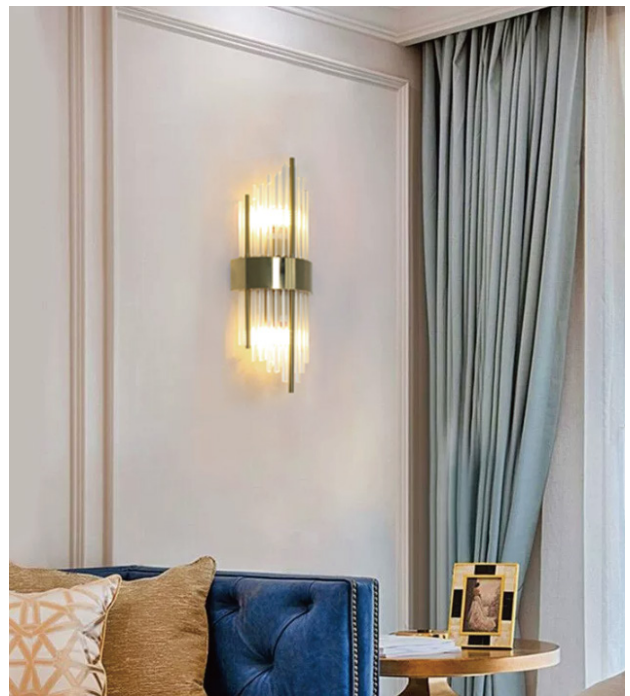
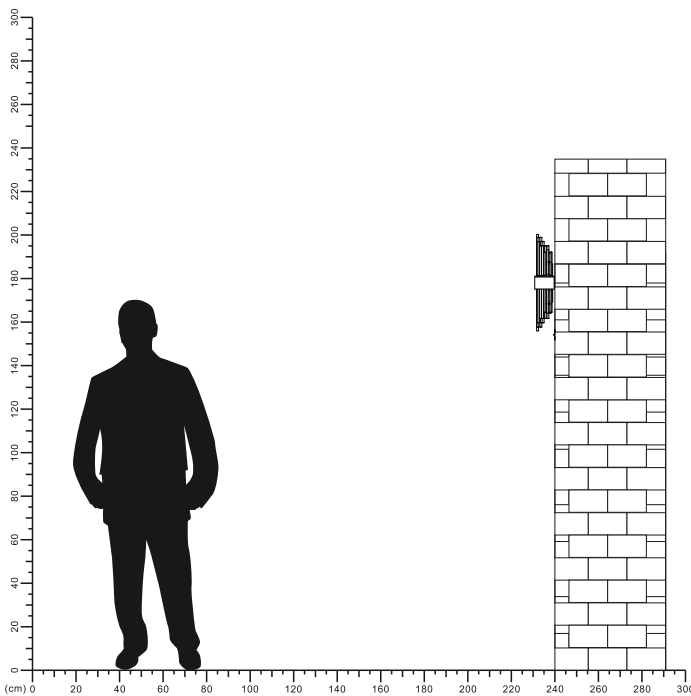

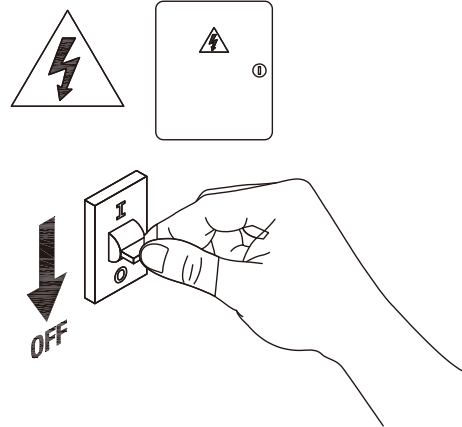
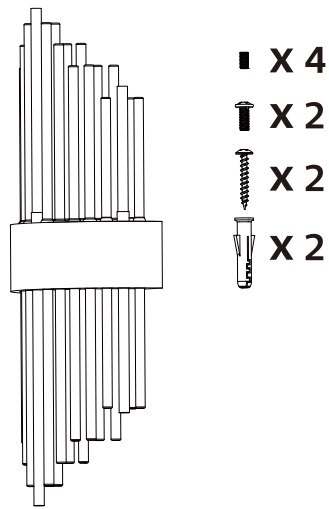

**1**

**Turn off the power**

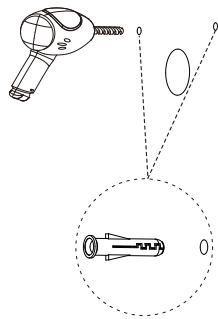

**2**

**Drill holes in the wall insert expansion screws**

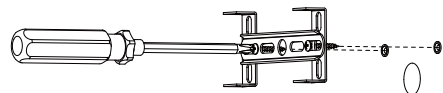

**3**

**To install the hanging board**

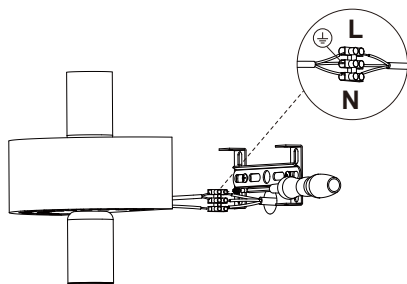

**4**

**Connecting the power cord**

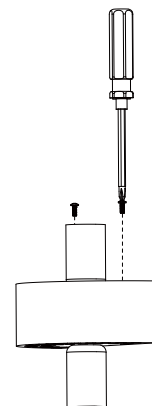

**5**

**Align the screw holes and tighten the screws**

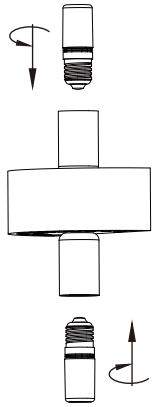

6

Tighten the bulb

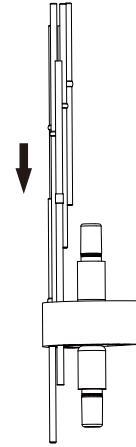

7

Align the hole and insert the lamp tube

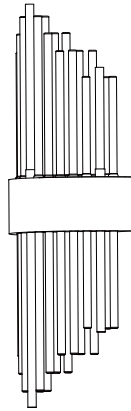

8

Installation completed

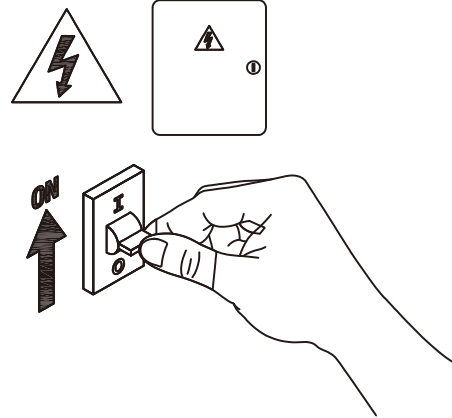

9

Turn on the power

