

Lamp Frame

NR-BG111 Series
IP20

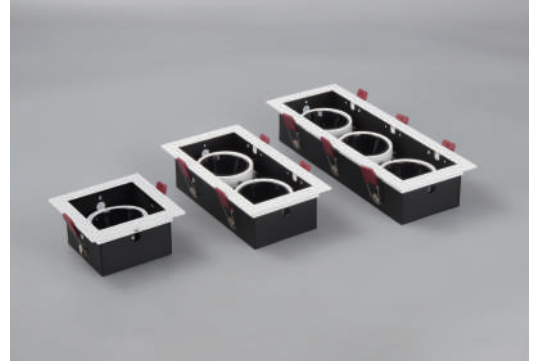

| Item Code | Match Lamp | Color | Dimensions in mm | | | Hole Size (mm) | kg |
|-----------------|------------|-------------|------------------|-----|----|----------------|------|
| | | | A | B | C | | |
| NR-BG111-1-Anti | GU10 | Black/White | 111 | 111 | 61 | 88*88 | 0.15 |
| NR-BG111-2-Anti | GU10 | Black/White | 206 | 111 | 61 | 88*182 | 0.25 |
| NR-BG111-3-Anti | GU10 | Black/White | 293 | 111 | 61 | 88*270 | 0.35 |

Dimensions in mm

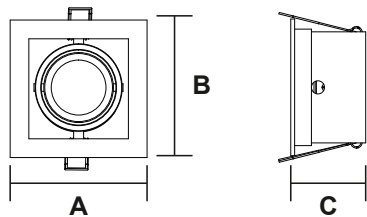

NR-BG111-1-Anti

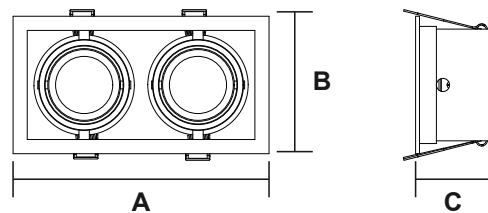

NR-BG111-2-Anti

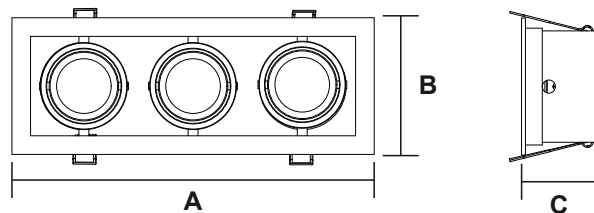

NR-BG111-3-Anti

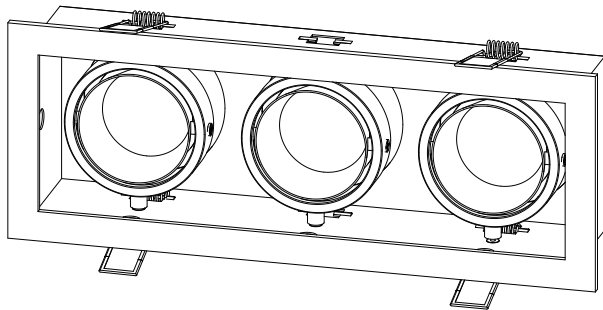

Description:

NR-BG11

Main material:

Die-cast aluminum + iron

Applications

- . Shoping mall
- . Office buildings
- . Exhibition hall

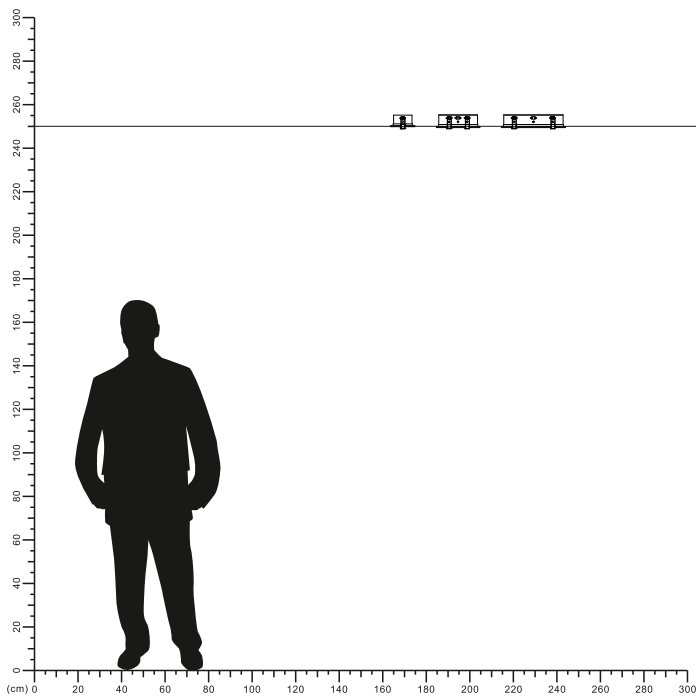

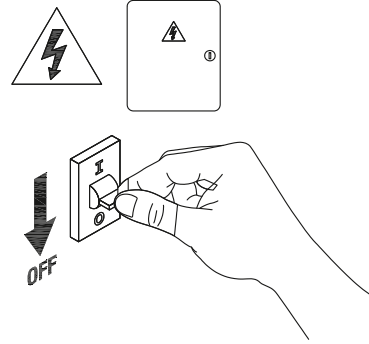
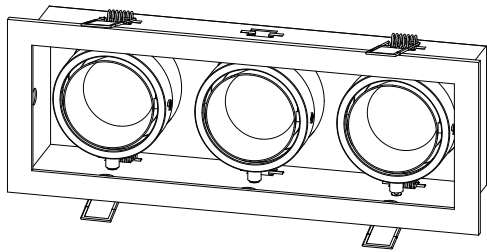

1

Turn off The Power

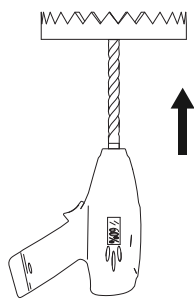

2

Cut a hole in the ceiling

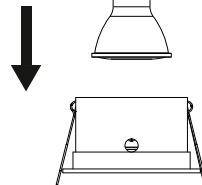

3

Snap the LED cup into the outer ring

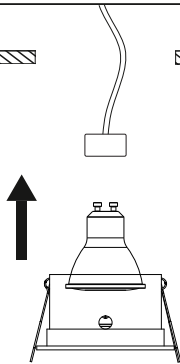

4

Snap the LED cup into the Lamp cup base

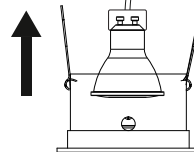

5

Buckle automatically fall down

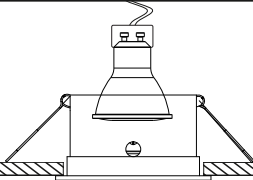

6

installaion is complete

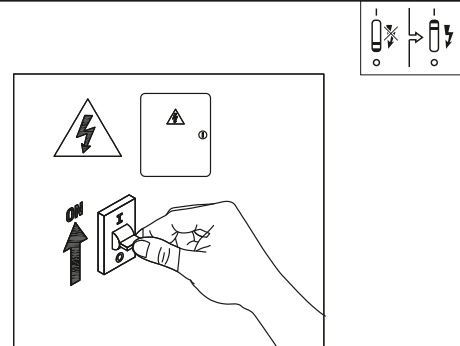

7

Turn on the power

