

LED Flood Light

NR-FL104-20-DOB
IP65



Outdoor 	AC 220-240V	50/60 Hz	PF ≥0.9	CCT 3000K	Ra ≥80	IP65	Beam Angle 90°	Chips SMD	
-------------	----------------	-------------	------------	--------------	-----------	------	----------------------	--------------	--

Item Code	P(W)	CCT(K)	Total Lumen	LM/W	Beam Angle	Dimensions in mm			kg
						A	B	C	
NR-FL104-20-DOB	20	3000/4000/6500	2100	105	90°	165	25	140	0.3

Dimensions in mm

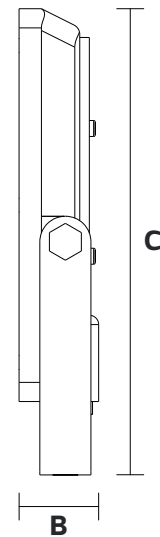
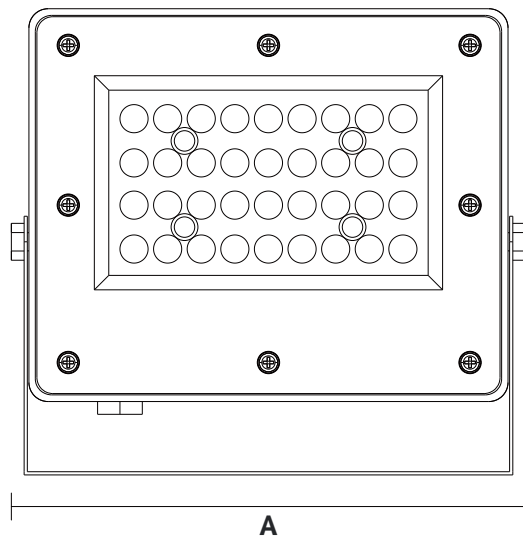

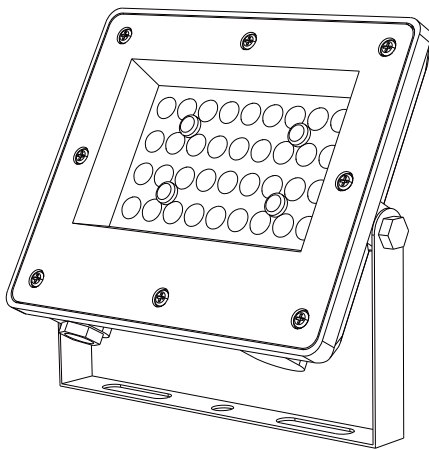

Description:
LED Flood Light

Main material:
Die-cast aluminum+ PC

Specification:
Energy saving, up to 85% energy saving comparing to standard halogen and in candescent lamps Long life, up to 30,000 hours High quality light, High color rending, less heat, no UV or IR radiation Build-in LED driver.

Applications
.Lawn
.Garden
.Building external wall

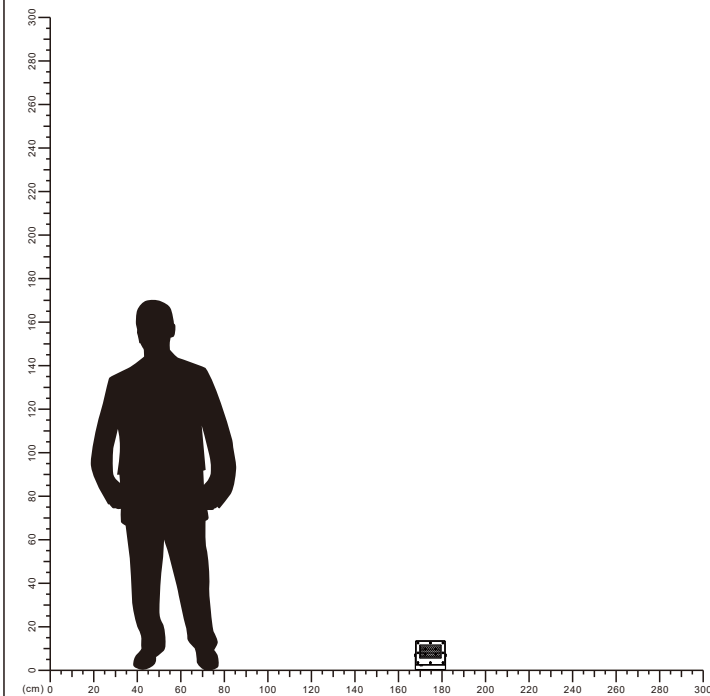

LUMINOUS INTENSITY DISTRIBUTION DIAGRAM

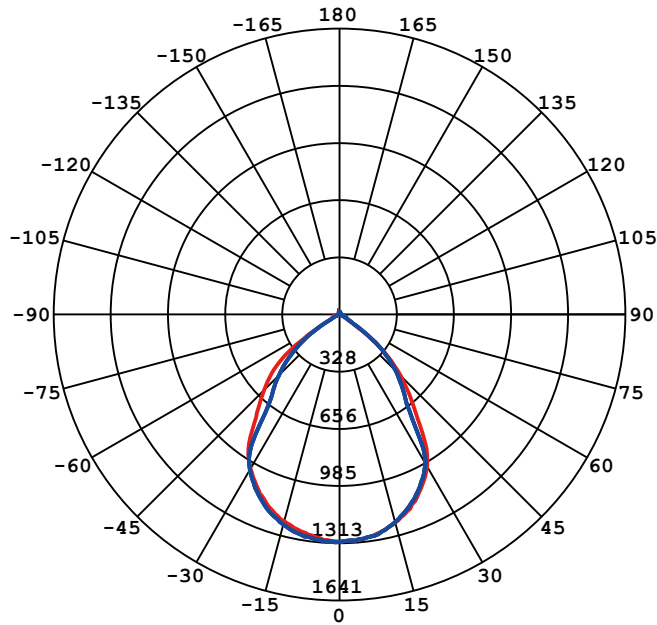

AVERAGE BEAM ANGLE (50%) : 83.1 DEG

Illuminance at a Distance

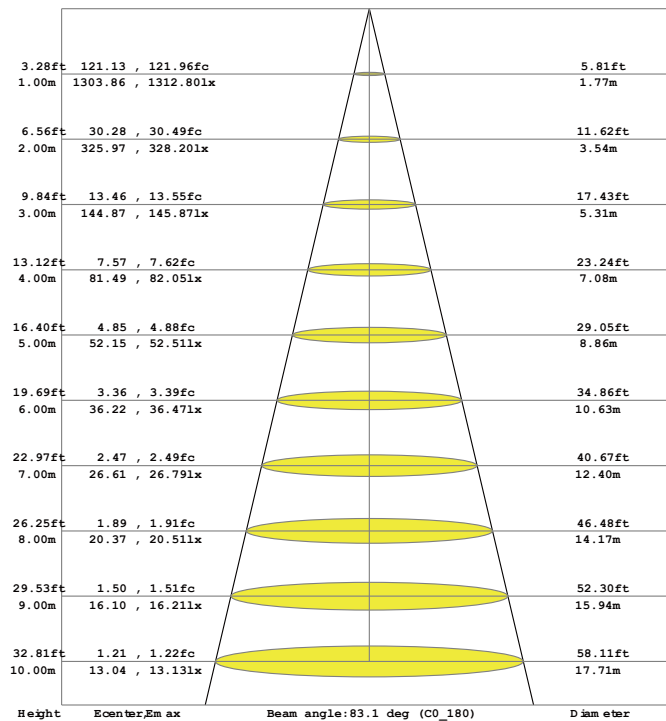

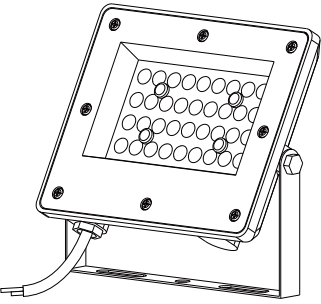
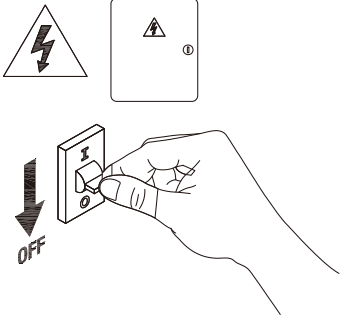
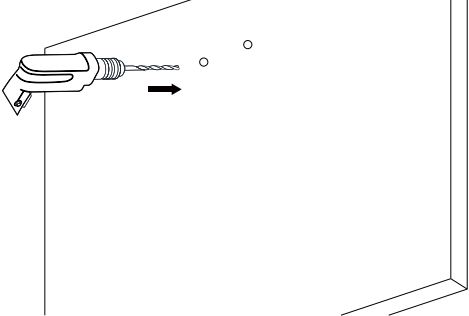
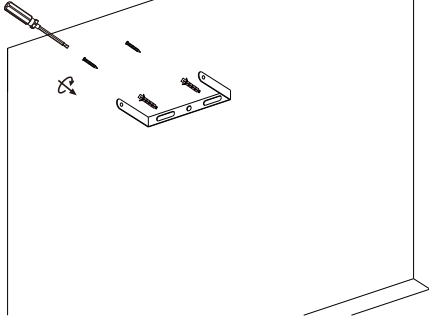
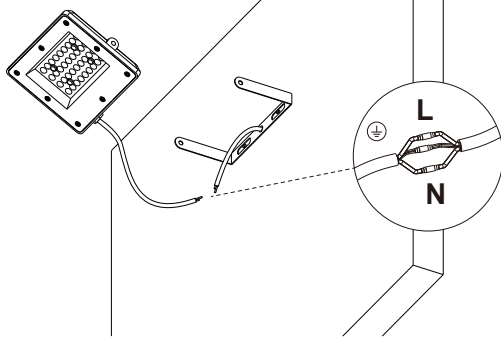
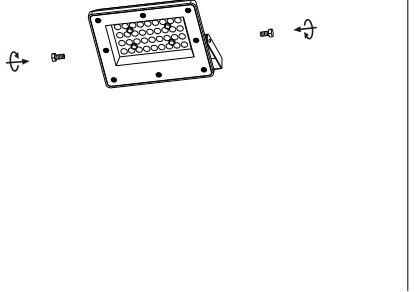
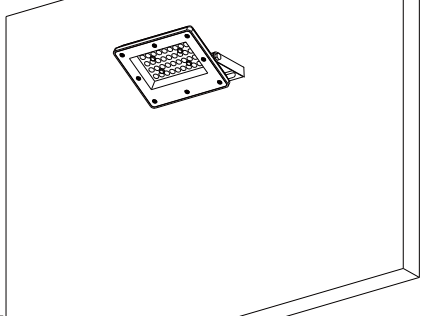
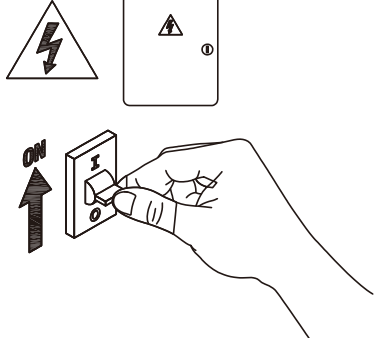
 <p>1</p>	 <p>2 Turn off the power</p>
 <p>3 Drill two screw holes on the wall</p>	 <p>4 Mount bracket on wall</p>
 <p>5 Connect cable</p>	 <p>6 Secure the lamp body to the support</p>
 <p>7 Installation completed</p>	 <p>8 Turn on power</p>

