

## G9 LED Lamp

NR-G9-4  
IP20



<b>SocKet</b> G9	<b>Indoor</b> 	<b>AC</b> 220-240V	<b>50/60</b> Hz	<b>CCT</b> 3000K	<b>Ra</b> ≥80	<b>IP20</b>	<b>Beam Angel</b> 270°	<b>Chips</b> SMD	
---------------------	-------------------	-----------------------	--------------------	---------------------	------------------	-------------	---------------------------	---------------------	--

Item Code	P(W)	Total Lumen	Beam Angle	CCT	Dimensions in mm		SocKet	
					A	B		kg
NR-G9-4-3000K	3.5	350	270°	3000K	42	Φ28	G9	0.02

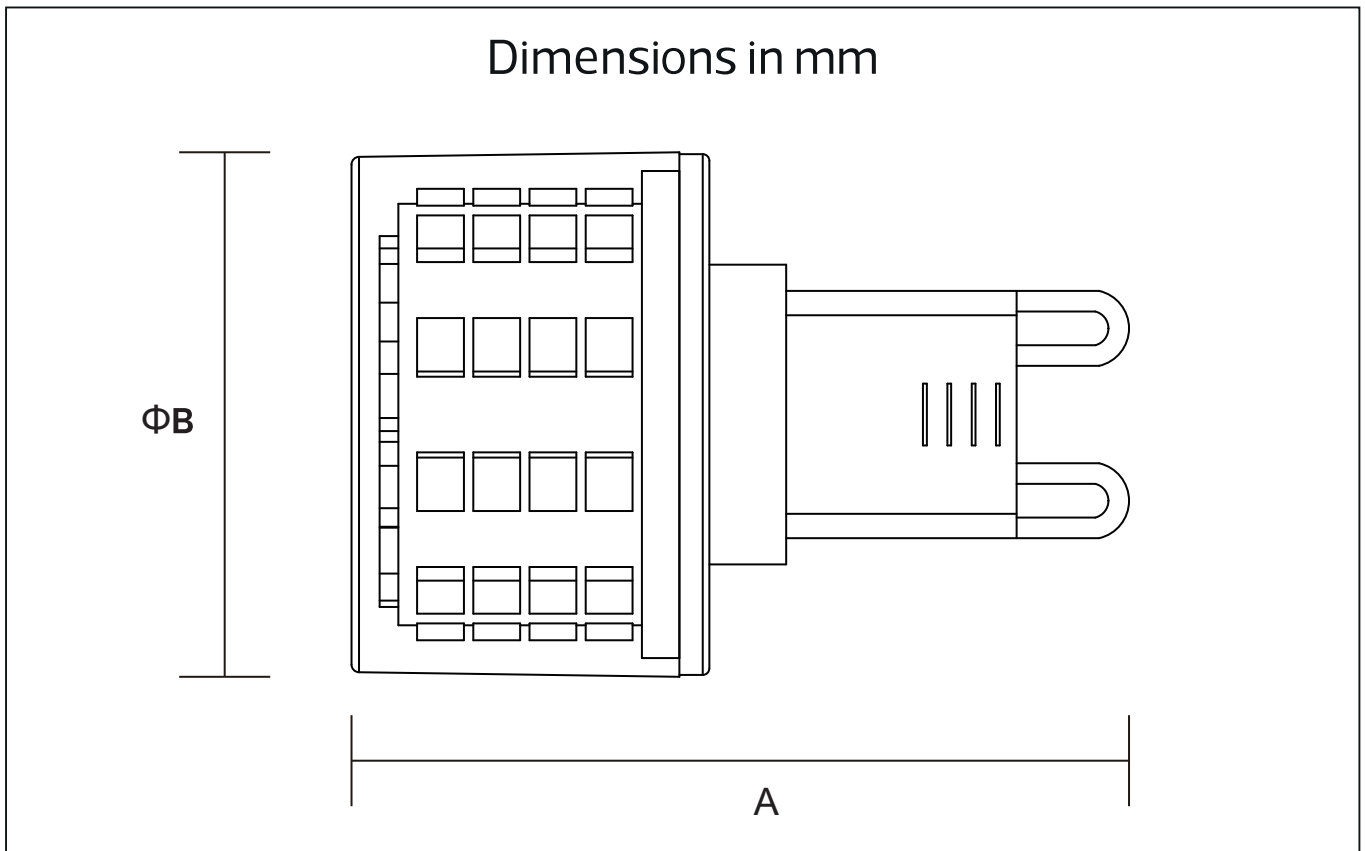

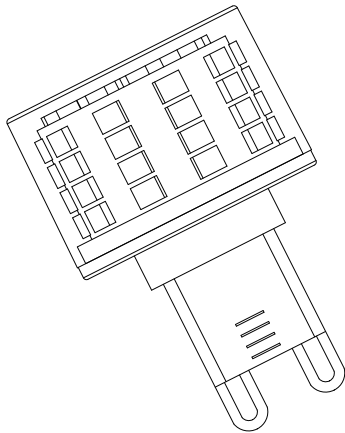





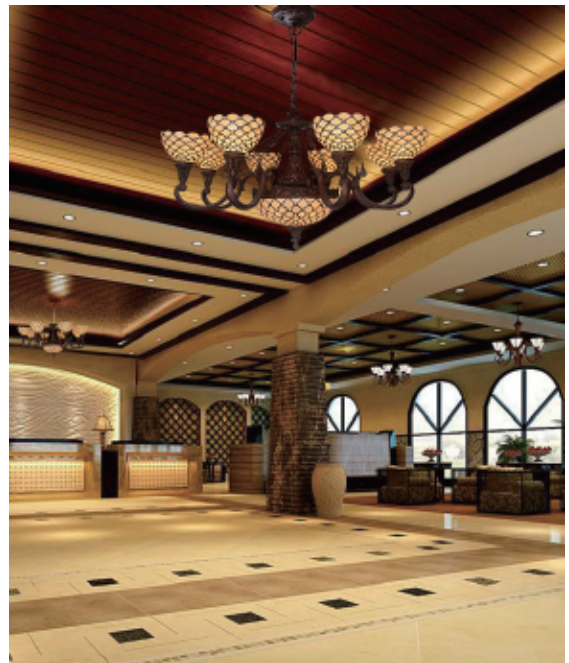
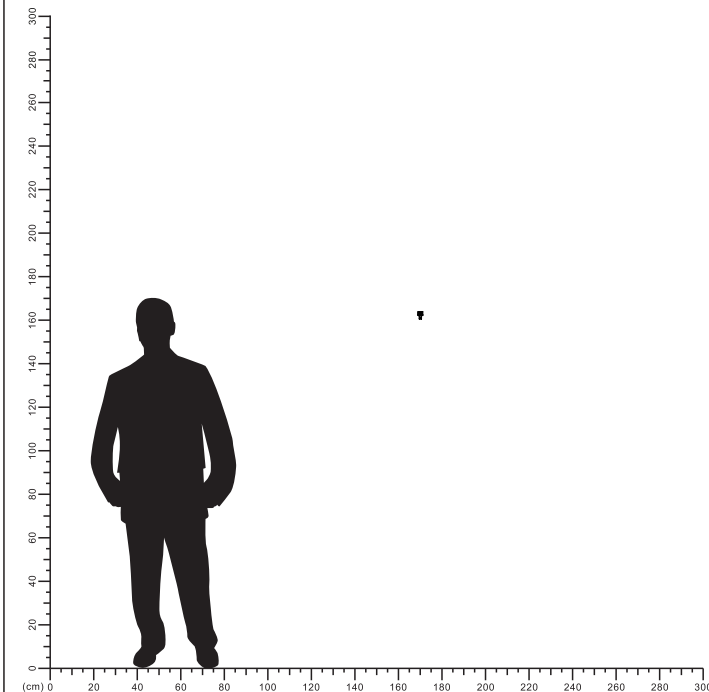

**Description:**  
G9 LED Lamp

**Main material:**  
Engineering plastics+Ceramics

**Specification**  
Energy saving, up to 85% energy saving  
comparing to standard halogen and incandescent  
lamps  
High quality light, high color rendering, less heat,  
no UV or IR radiation  
Build-in LED Driver  
IP20

**Applications**  
.Shopping mall  
.Hotels  
.Exhibition hall  
.Art hall  
.Museums



-  x1
-  x1
-  x2
-  x2
-  x4

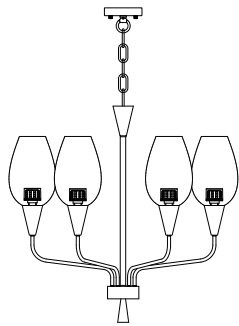

Ceiling Lamps

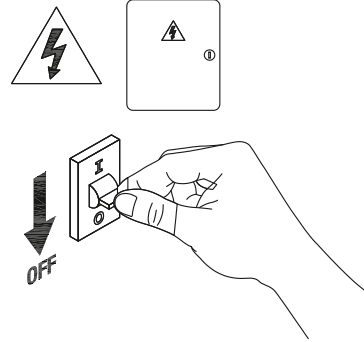

1

Turn off The Power

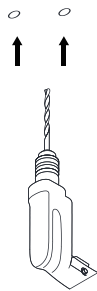

2

Sketchpad drill two screw holes in the day

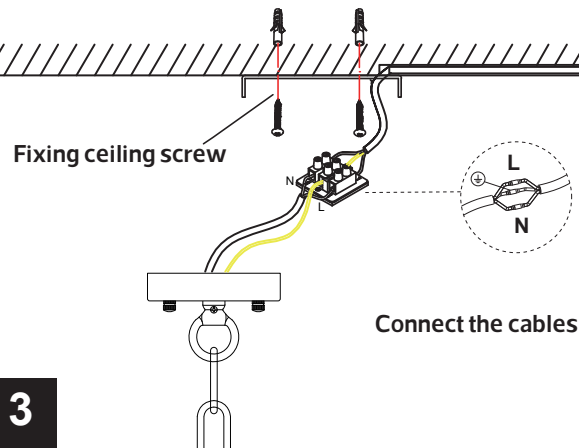

3

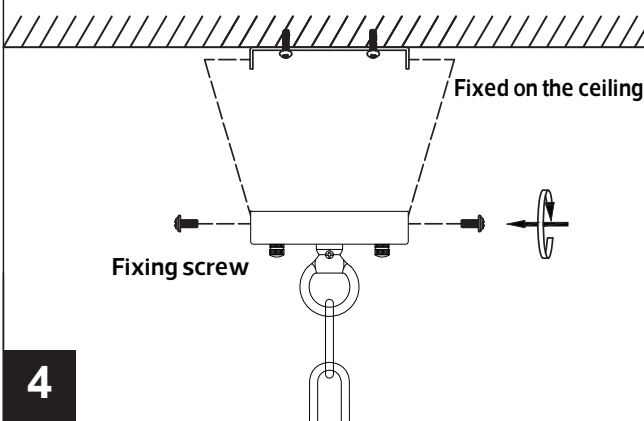

4

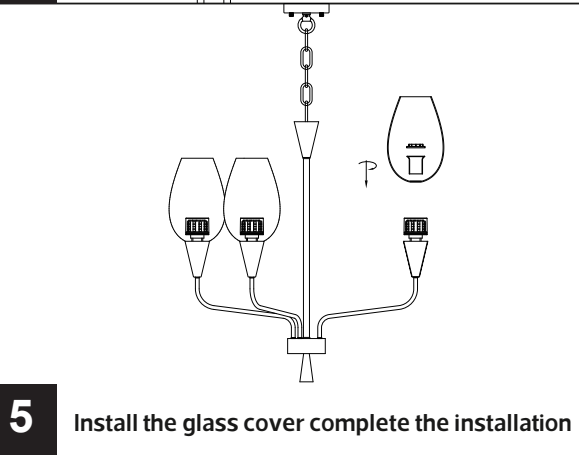

5

Install the glass cover complete the installation

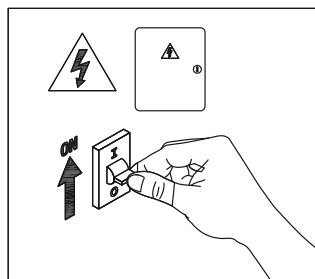

6

Turn on the power

