

## LED Magnetic Track System

NR-S20/S35-DL105 Series  
IP20

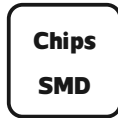
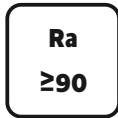

Item Code	P(W)	Using Track	Total Lumen	Beam Angle	Dimensions in mm			kg
					A	B	C	
NR-S35-DL105-6	6	NR-S35	426	24°/60°	147.5	34	70	0.17
NR-S35-DL105-10	10	NR-S35	710	24°/60°	272	34	70	0.32
NR-S35-DL105-15	15	NR-S35	1155	24°/60°	538	34	70	0.55
NR-S35-DL105-30	30	NR-S35	2700	24°/60°	1104	34	70	0.95
NR-S20-DL105-10	10	NR-S20	710	24°/60°	294	23	43	0.20
NR-S20-DL105-15	15	NR-S20	1155	24°/60°	582	23	43	0.35

### Dimensions in mm

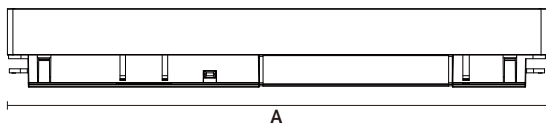

NR-S20-DL105

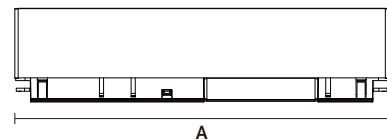

NR-S35-DL105

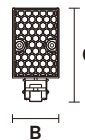

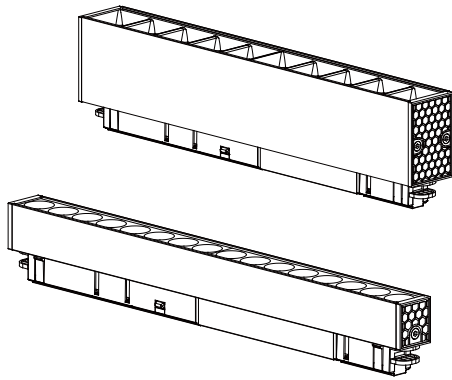

**Description:**  
LED Magnetic Track System

**Main material:**  
Aluminum shell, engineering plastic

**Specification:**  
Energy saving, up to 85% energy saving comparing to standard halogen and incandescent lamps  
High quality light, high color rendering, less heat, no UV or IR radiation  
Build-in LED Driver

**Applications**  
.Office  
.Meeting room  
.Sitting room

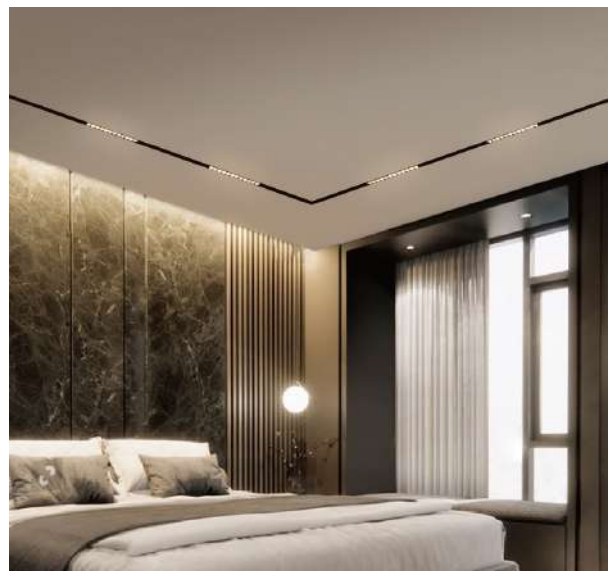
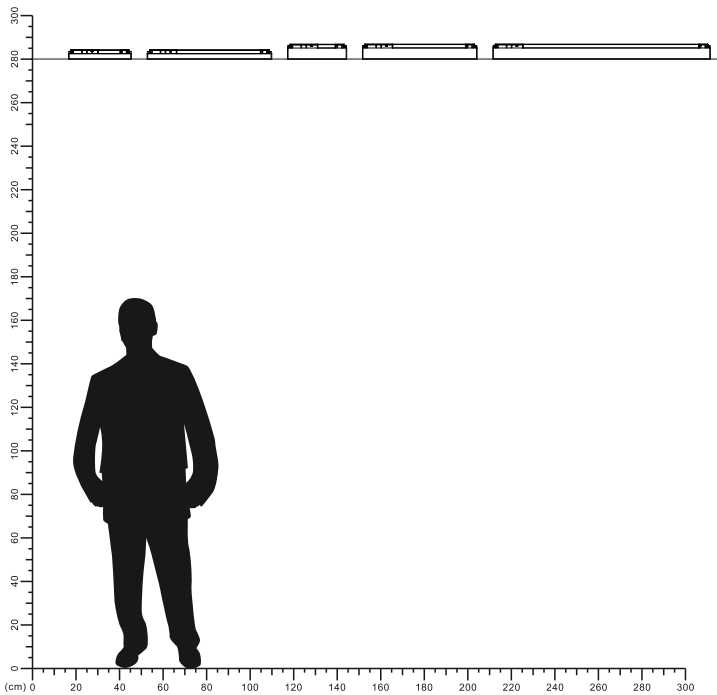

# LUMINOUS INTENSITY DISTRIBUTION DIAGRAM

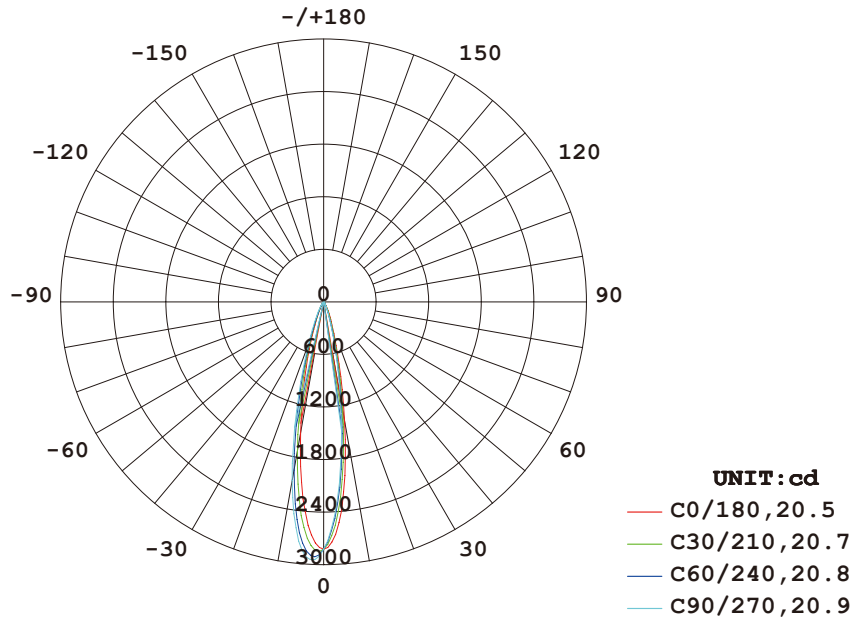

**AVERAGE BEAM ANGLE (50%) : 20.7 DEG**

## Illuminance at a Distance

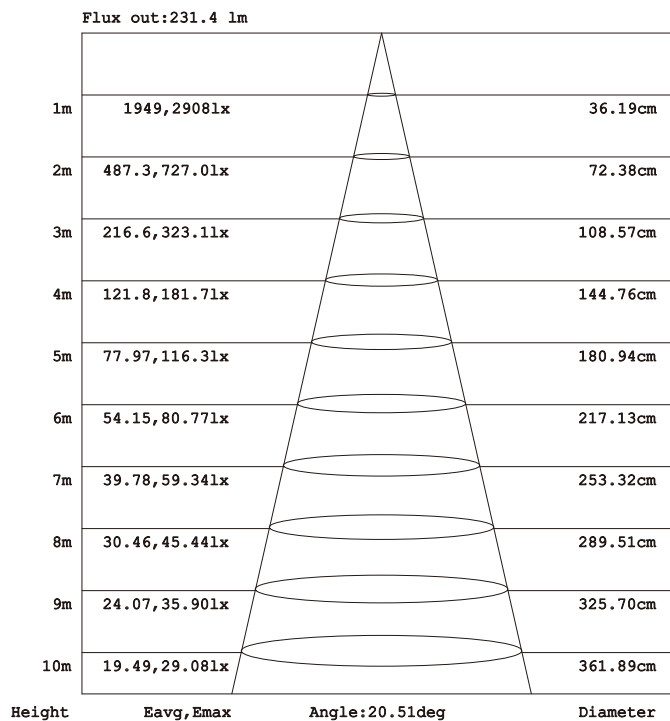

**Model: NR-S35-DL105-6 24°**

# LUMINOUS INTENSITY DISTRIBUTION DIAGRAM

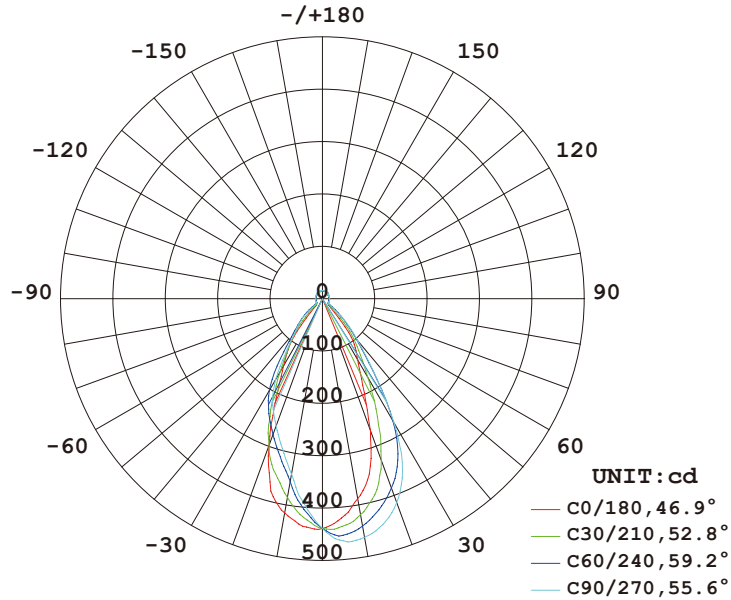

**AVERAGE BEAM ANGLE (50%) : 53.6 DEG**

## Illuminance at a Distance

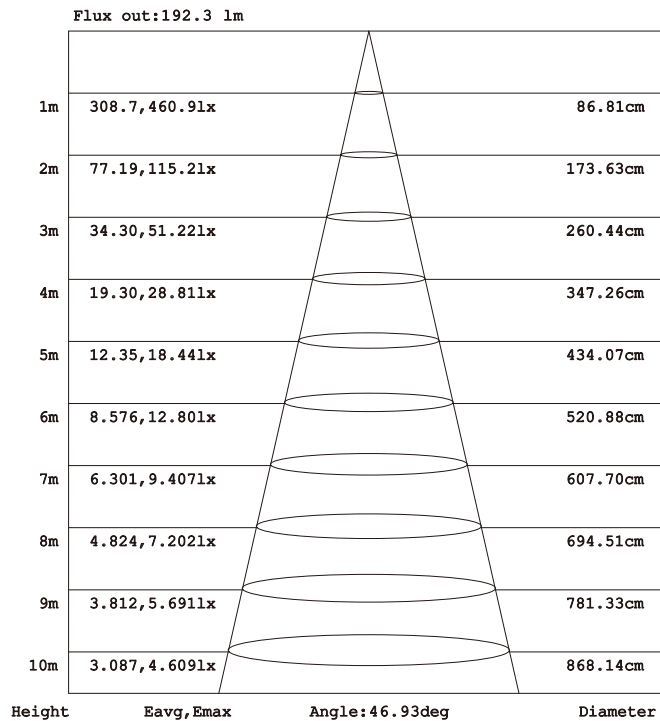

**Model: NR-S35-DL105-6 60°**

# LUMINOUS INTENSITY DISTRIBUTION DIAGRAM

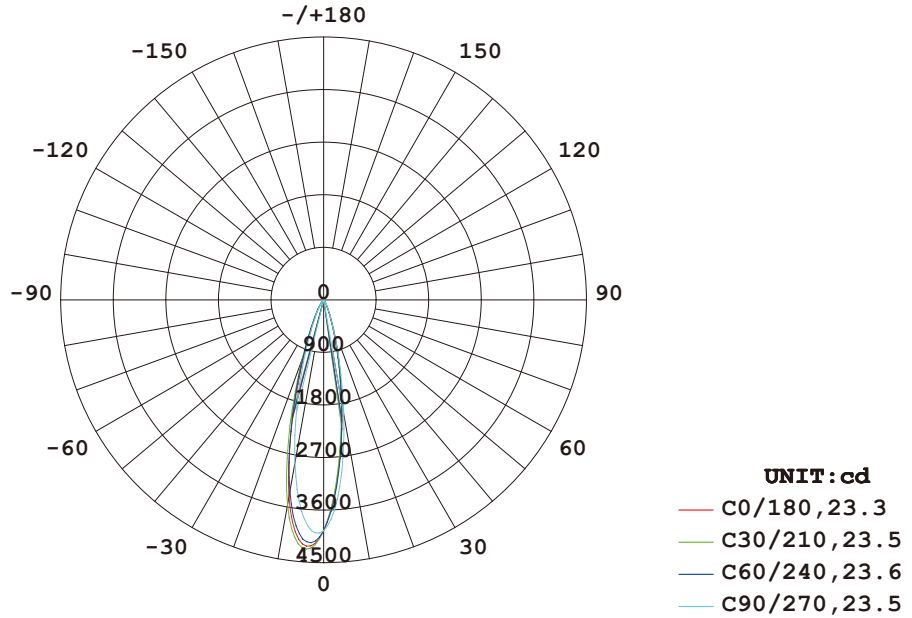

**AVERAGE BEAM ANGLE (50%) : 23.5 DEG**

## Illuminance at a Distance

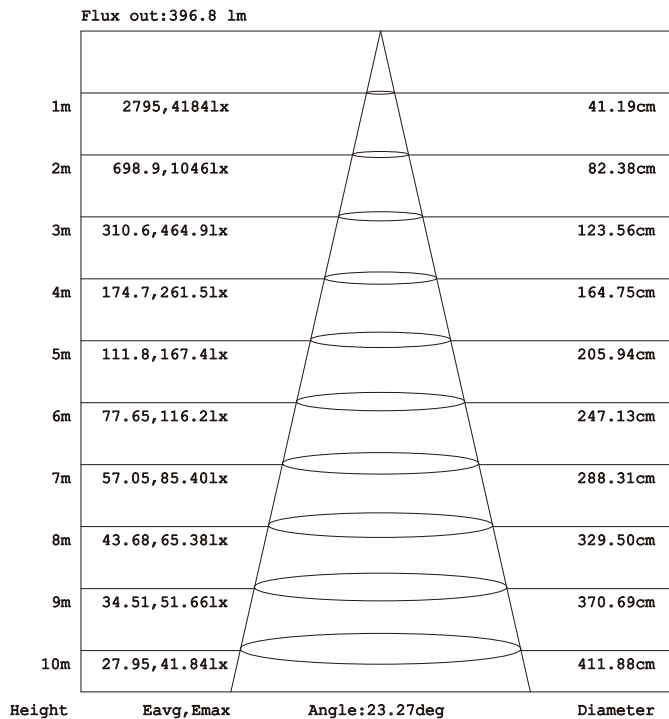

**Model:NR-S35-DL105-10 24°**

# LUMINOUS INTENSITY DISTRIBUTION DIAGRAM

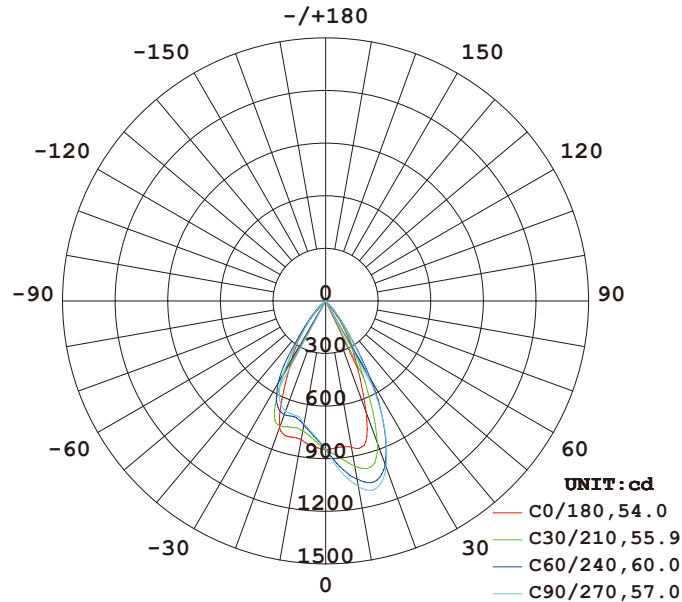

**AVERAGE BEAM ANGLE (50%) : 56.7 DEG**

## Illuminance at a Distance

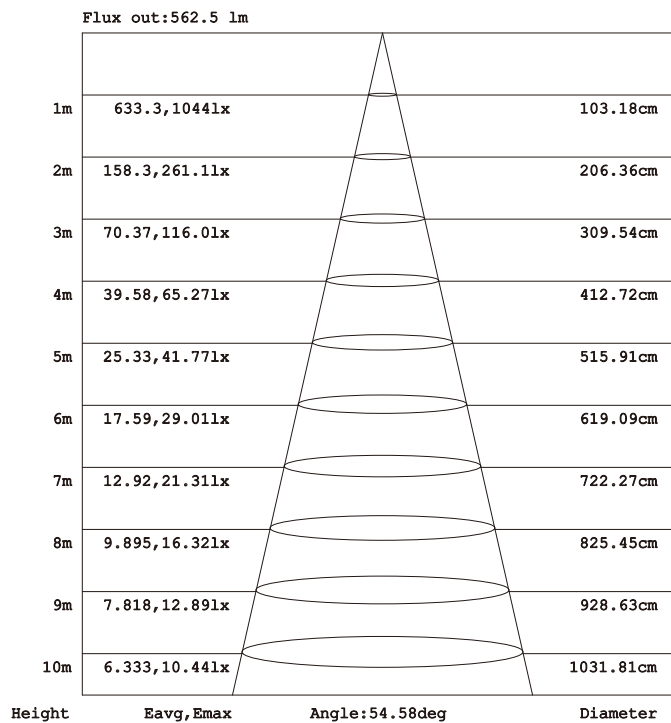

**Model:NR-S35-DL105-10 60°**

# LUMINOUS INTENSITY DISTRIBUTION DIAGRAM

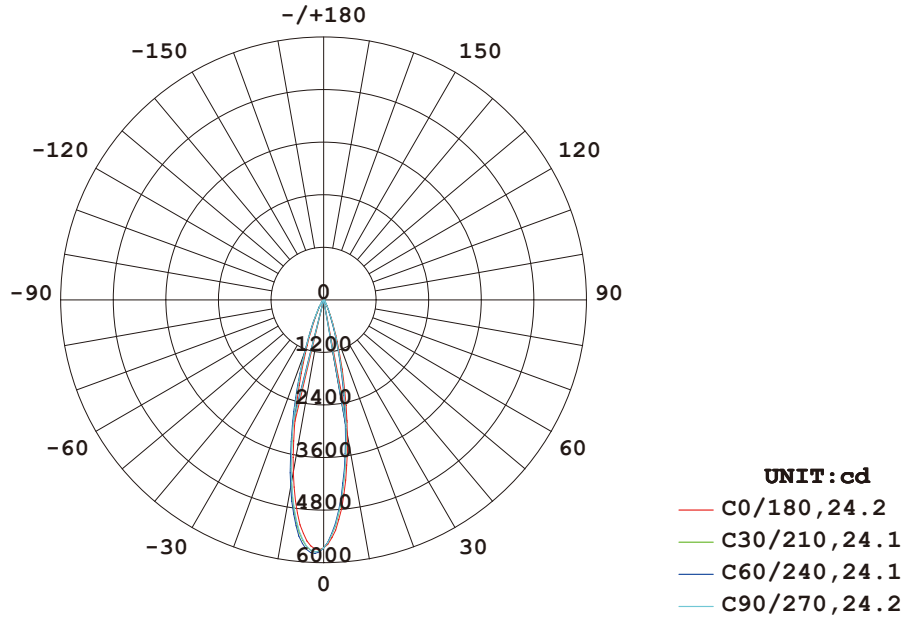

**AVERAGE BEAM ANGLE (50%) : 24.2 DEG**

## Illuminance at a Distance

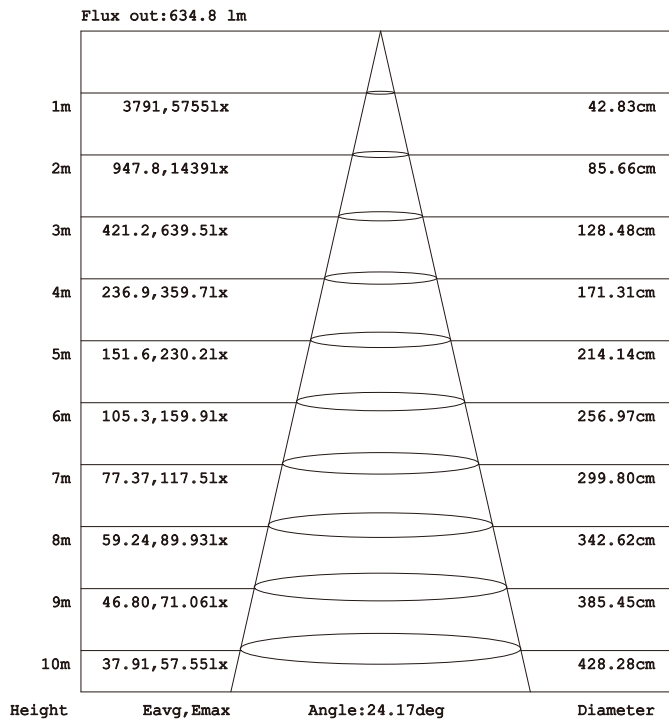

**Model:NR-S35-DL105-15 24°**

# LUMINOUS INTENSITY DISTRIBUTION DIAGRAM

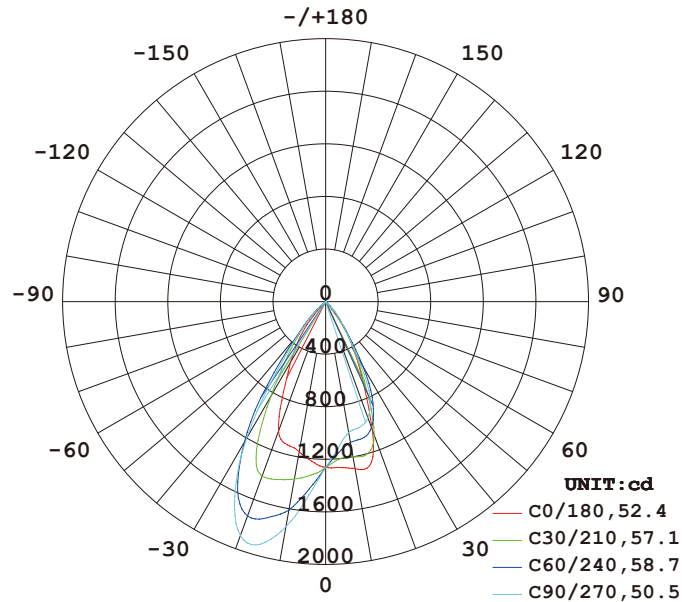

**AVERAGE BEAM ANGLE (50%) : 54.7 DEG**

## Illuminance at a Distance

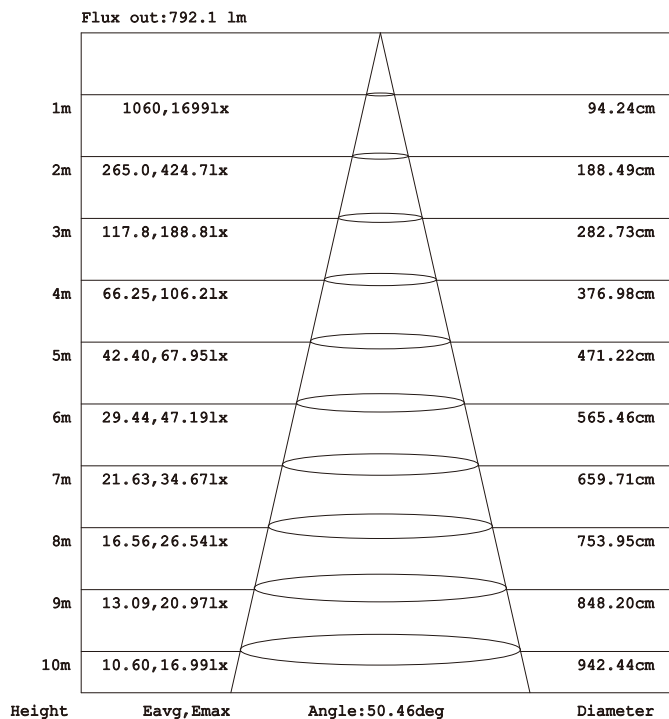

**Model: NR-S35-DL105-15 60°**



# LUMINOUS INTENSITY DISTRIBUTION DIAGRAM

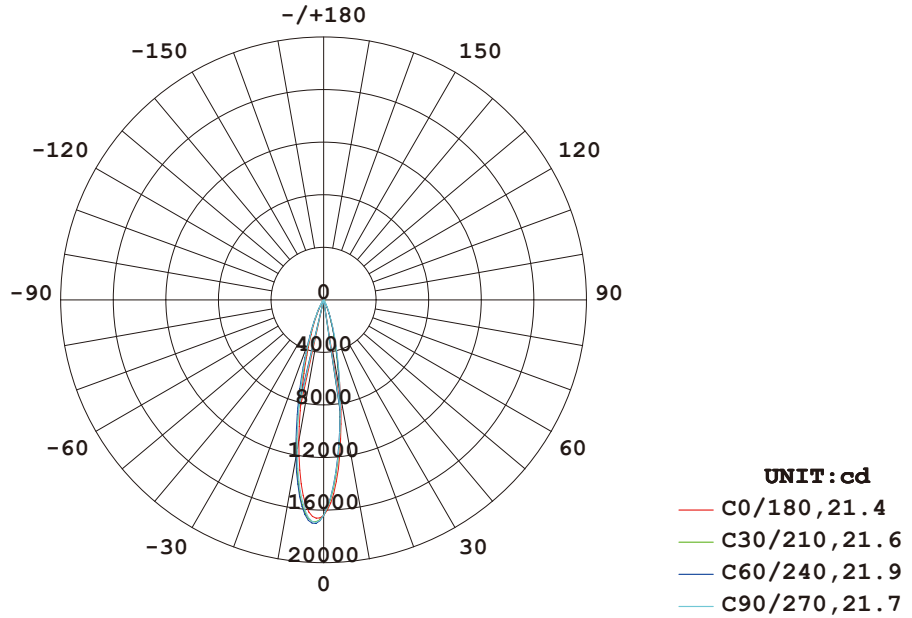

**AVERAGE BEAM ANGLE (50%) : 21.6 DEG**

## Illuminance at a Distance

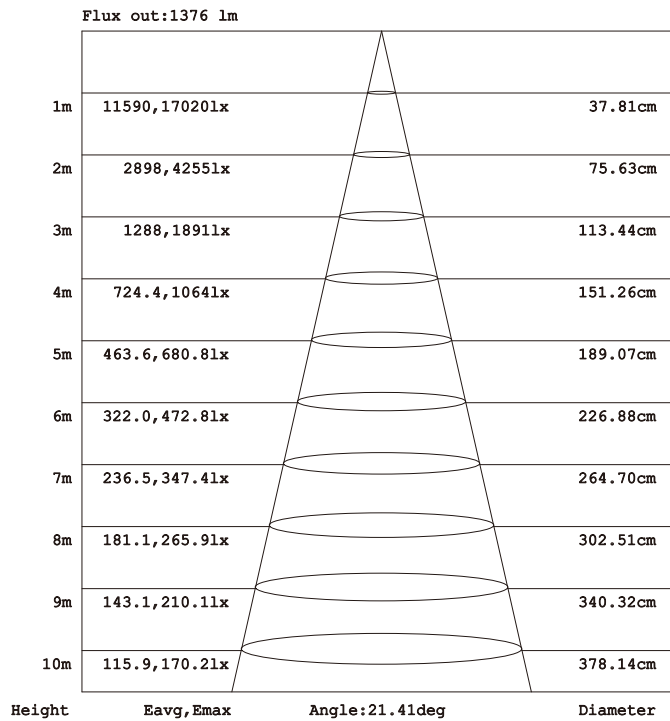

**Model: NR-S35-DL105-30 24°**

# LUMINOUS INTENSITY DISTRIBUTION DIAGRAM

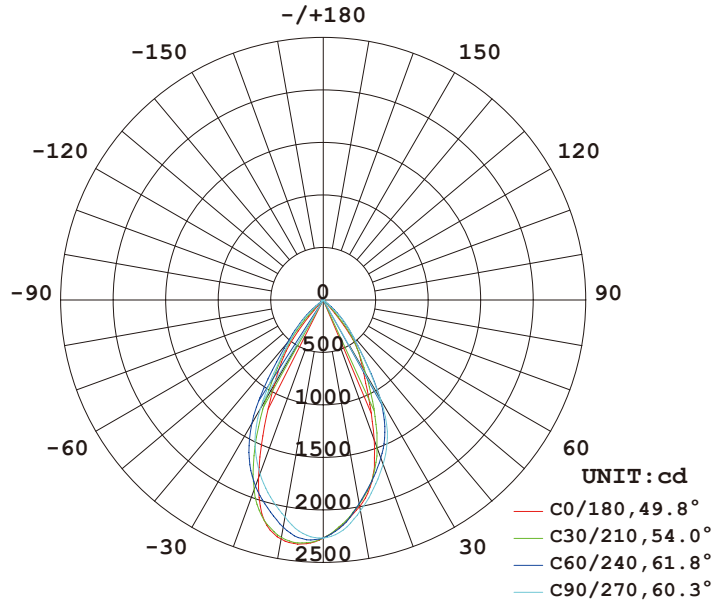

**AVERAGE BEAM ANGLE (50%) : 56.5 DEG**

## Illuminance at a Distance

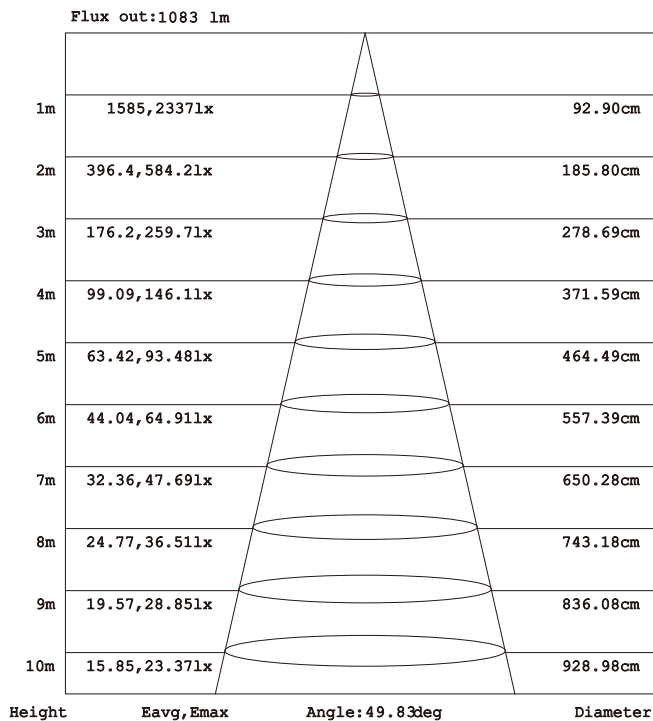

**Model: NR-S35-DL105-30 60°**

# LUMINOUS INTENSITY DISTRIBUTION DIAGRAM

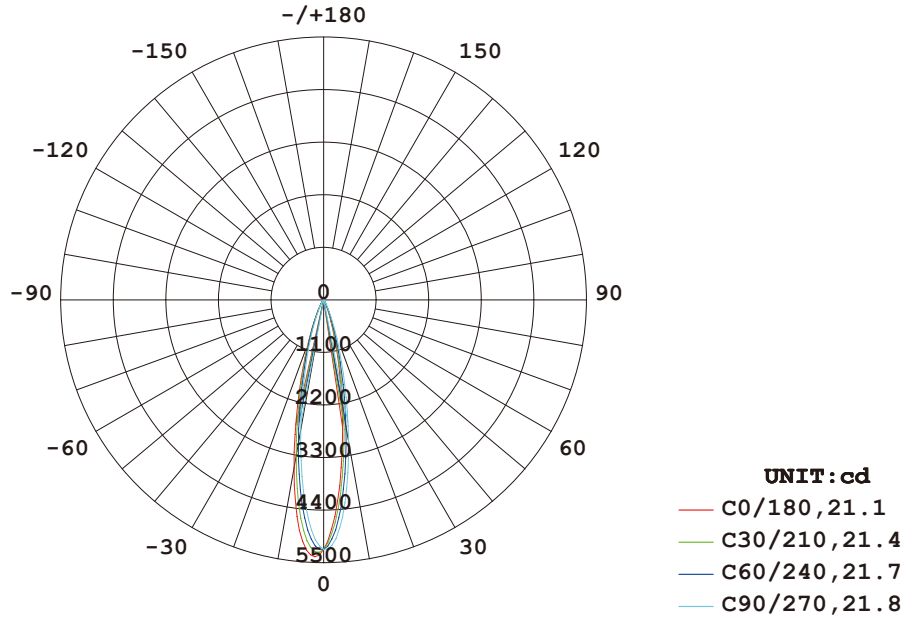

**AVERAGE BEAM ANGLE (50%) : 21.5 DEG**

## Illuminance at a Distance

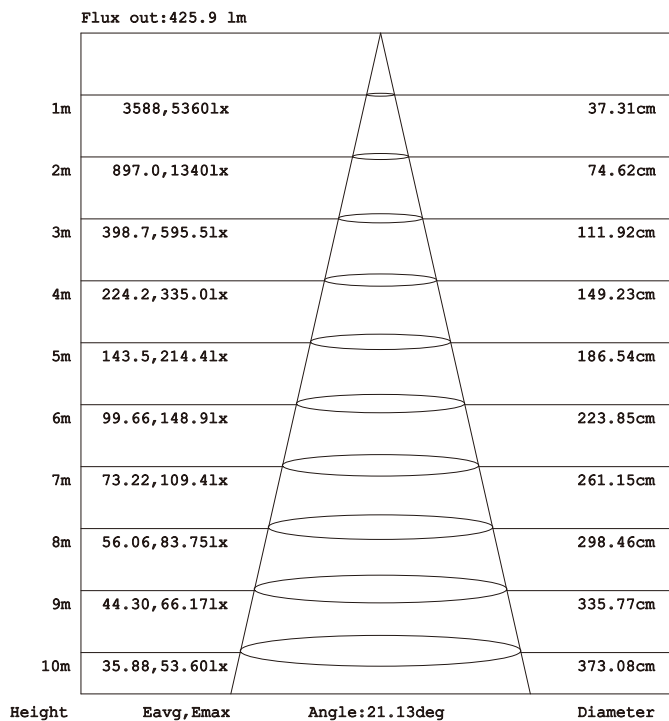

**Model: NR-S20-DL105-10 24°**

# LUMINOUS INTENSITY DISTRIBUTION DIAGRAM

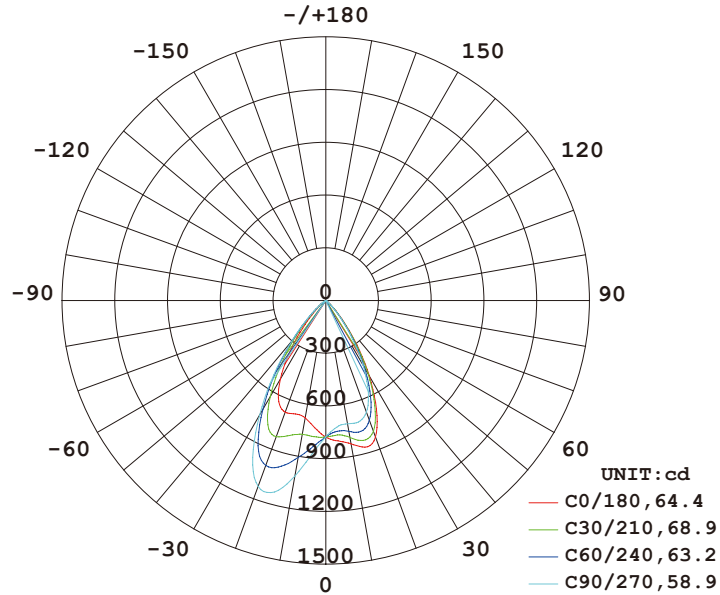

**AVERAGE BEAM ANGLE (50%) : 63.9 DEG**

## Illuminance at a Distance

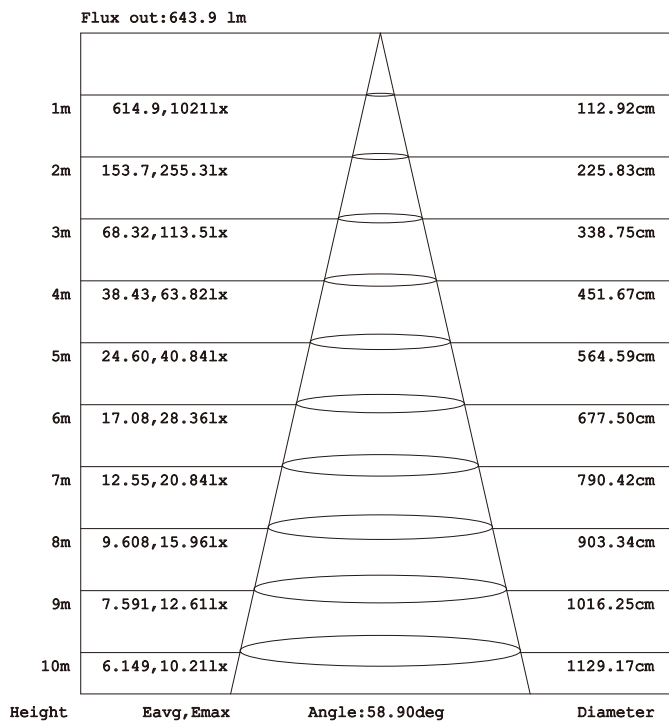

**Model:NR-S20-DL105-10 60°**

# LUMINOUS INTENSITY DISTRIBUTION DIAGRAM

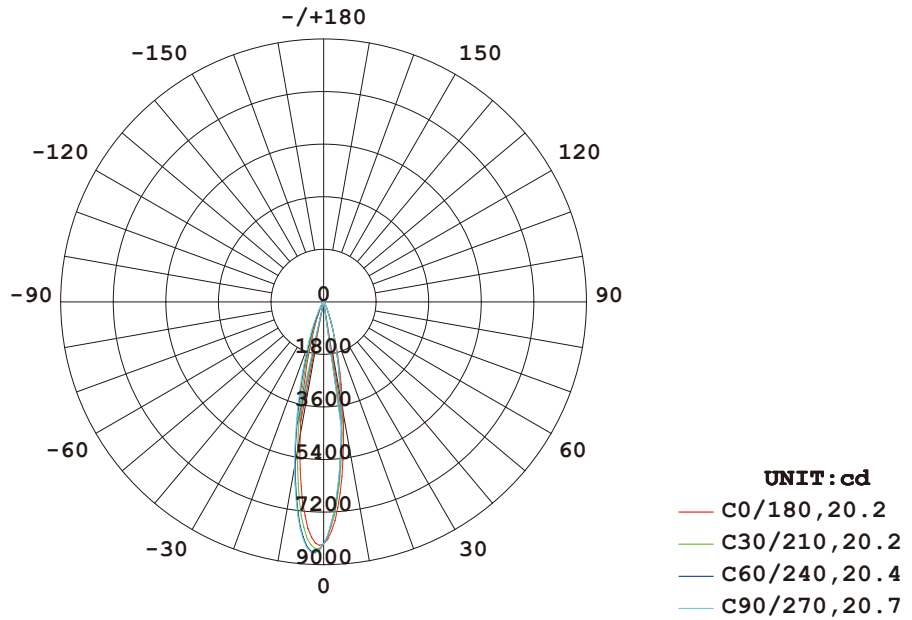

**AVERAGE BEAM ANGLE (50%) : 20.4 DEG**

## Illuminance at a Distance

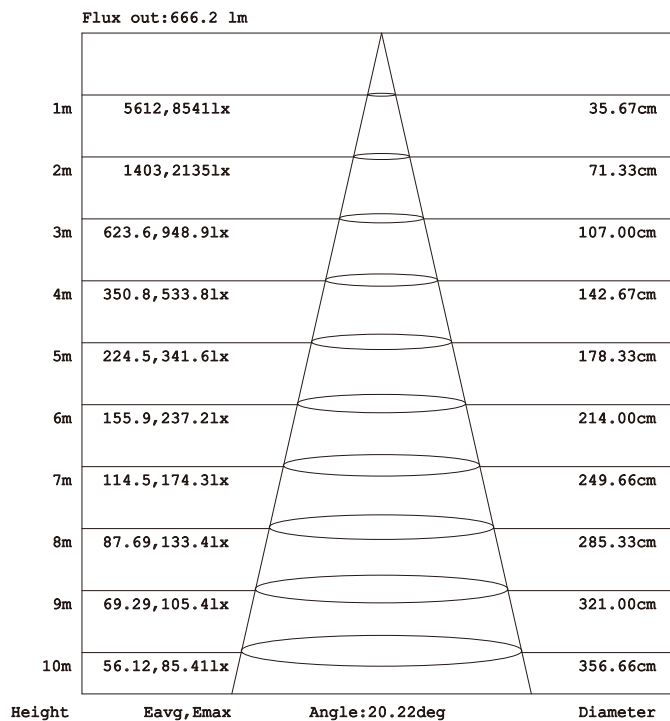

**Model: NR-S20-DL105-15 24°**

# LUMINOUS INTENSITY DISTRIBUTION DIAGRAM

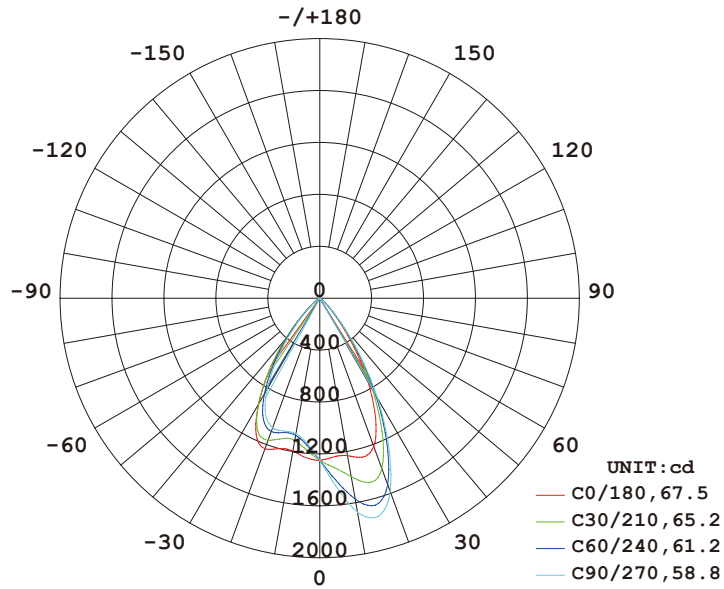

**AVERAGE BEAM ANGLE (50%) : 63.2 DEG**

## Illuminance at a Distance

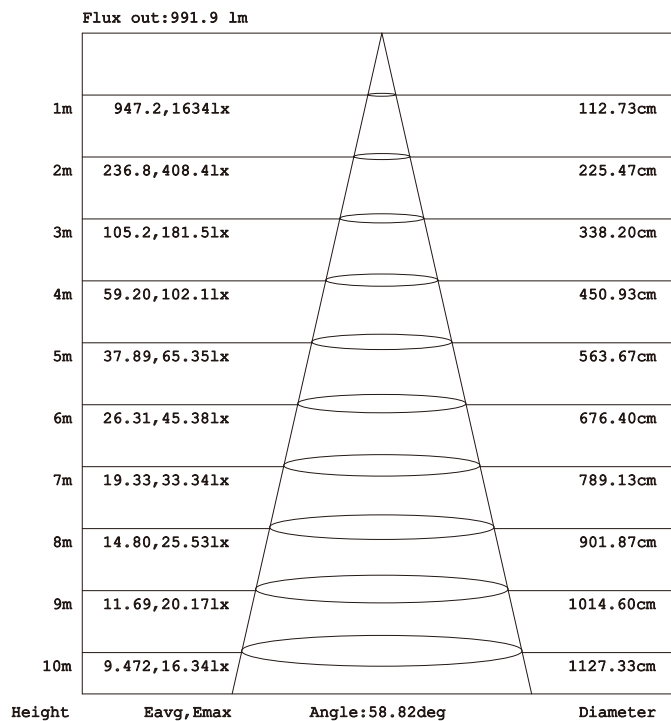

**Model:NR-S20-DL105-15 60°**

