

LED Magnetic Track System

NR-S20/S35-DL105 Series
IP20

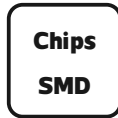
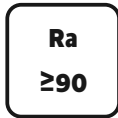

Item Code	P(W)	Using Track	Total Lumen	Beam Angle	Dimensions in mm			kg
					A	B	C	
NR-S35-DL105-6	6	NR-S35	426	24°/60°	147.5	34	70	0.17
NR-S35-DL105-10	10	NR-S35	710	24°/60°	272	34	70	0.32
NR-S35-DL105-15	15	NR-S35	1155	24°/60°	538	34	70	0.55
NR-S35-DL105-30	30	NR-S35	2700	24°/60°	1104	34	70	0.95
NR-S20-DL105-10	10	NR-S20	710	24°/60°	294	23	43	0.20
NR-S20-DL105-15	15	NR-S20	1155	24°/60°	582	23	43	0.35

Dimensions in mm



NR-S20-DL105

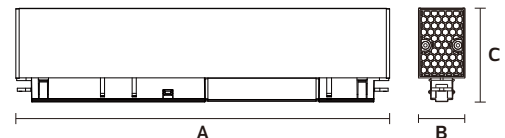

NR-S35-DL105

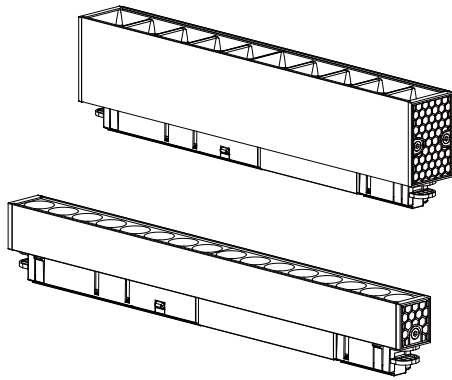

Description:
LED Magnetic Track System

Main material:
Aluminum shell, engineering plastic

Specification:
Energy saving, up to 85% energy saving comparing to standard halogen and incandescent lamps
High quality light, high color rendering, less heat, no UV or IR radiation
Build-in LED Driver

Applications
.Office
.Meeting room
.Sitting room

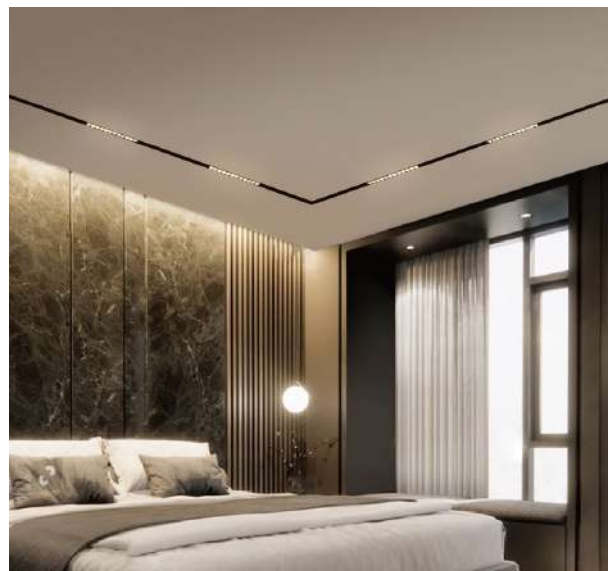
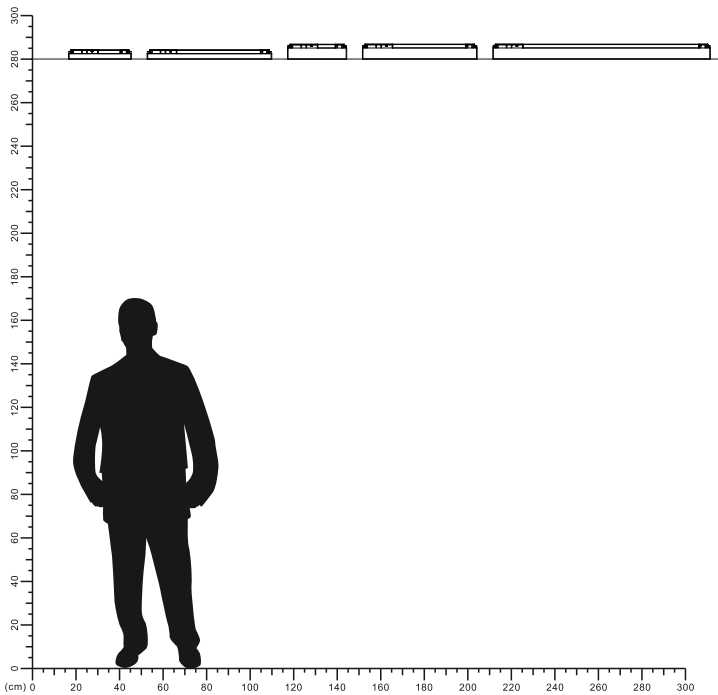

LUMINOUS INTENSITY DISTRIBUTION DIAGRAM

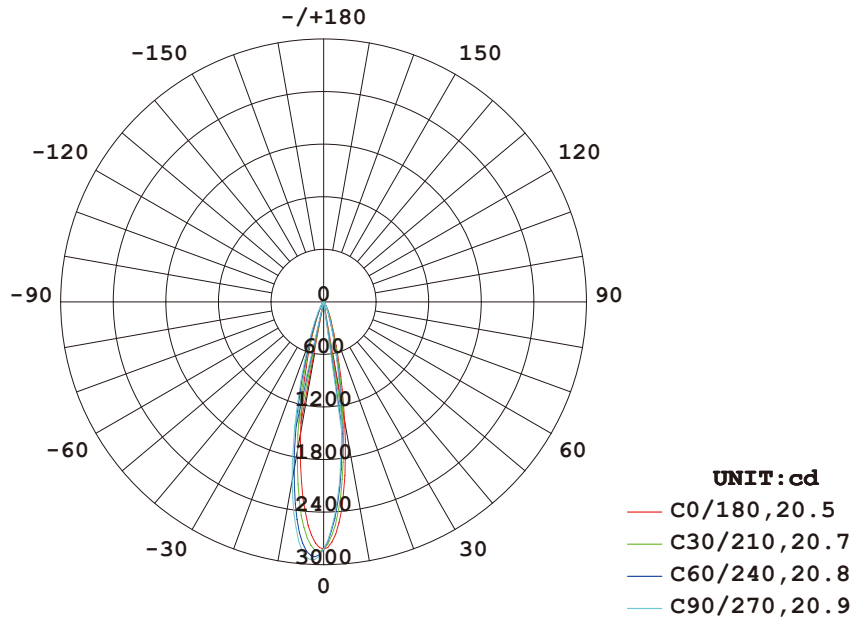

AVERAGE BEAM ANGLE (50%) : 20.7 DEG

Illuminance at a Distance

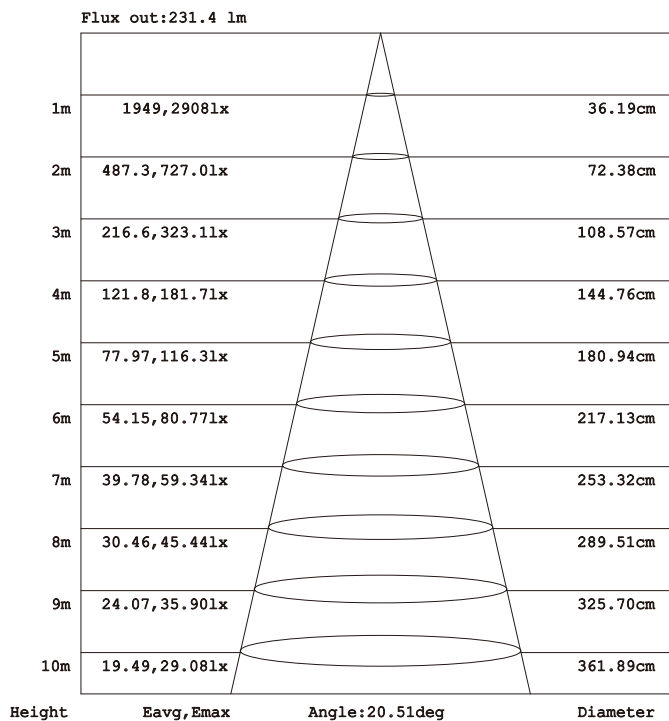

Model: NR-S35-DL105-6 24°

LUMINOUS INTENSITY DISTRIBUTION DIAGRAM

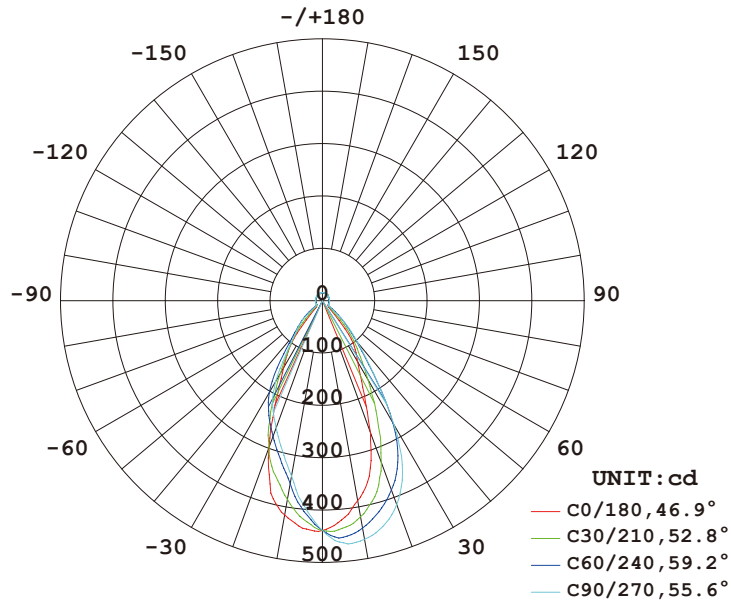

AVERAGE BEAM ANGLE (50%) : 53.6 DEG

Illuminance at a Distance

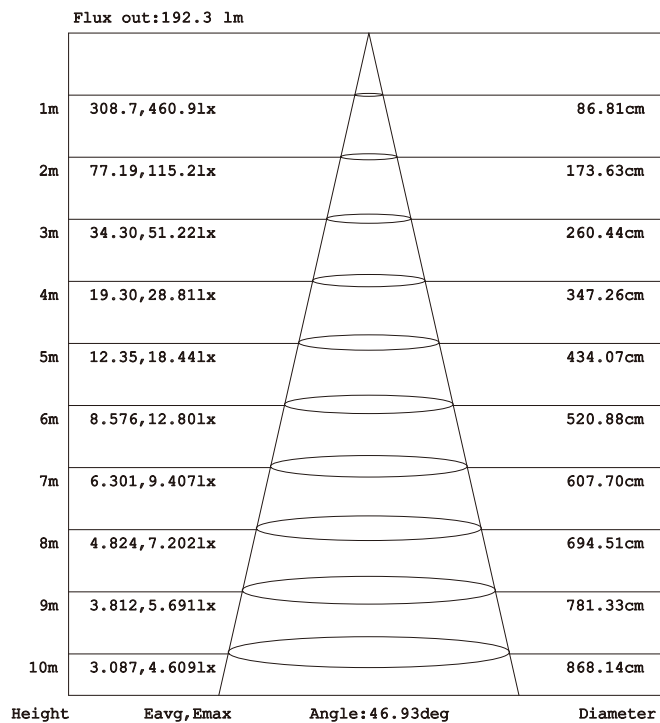

Model:NR-S35-DL105-6 60°

LUMINOUS INTENSITY DISTRIBUTION DIAGRAM

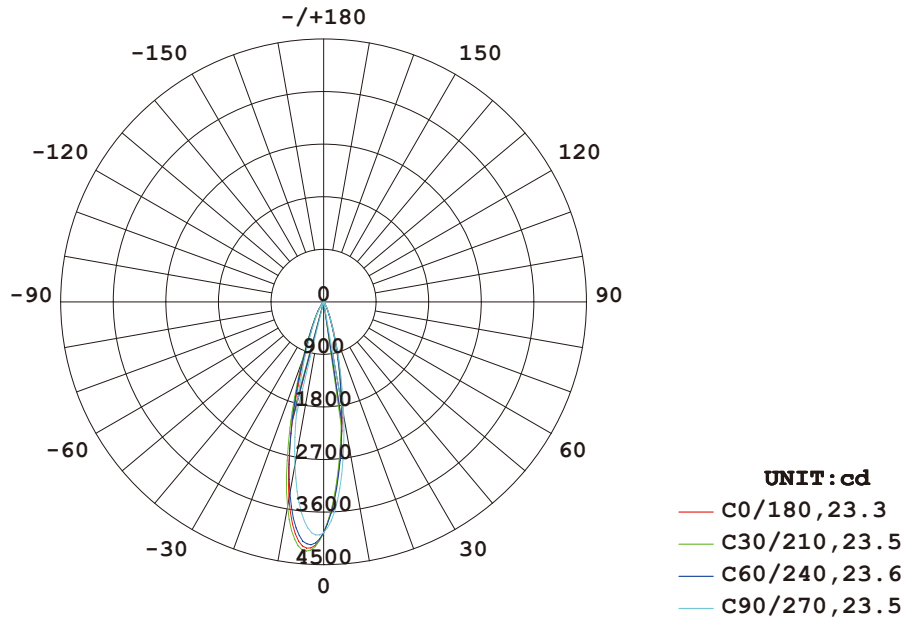

AVERAGE BEAM ANGLE (50%) : 23.5 DEG

Illuminance at a Distance

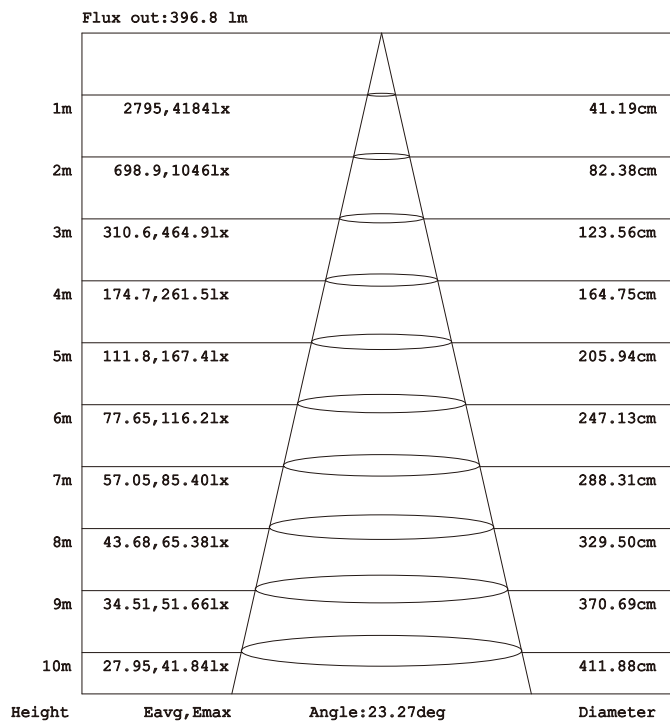

Model: NR-S35-DL105-10 24°

LUMINOUS INTENSITY DISTRIBUTION DIAGRAM

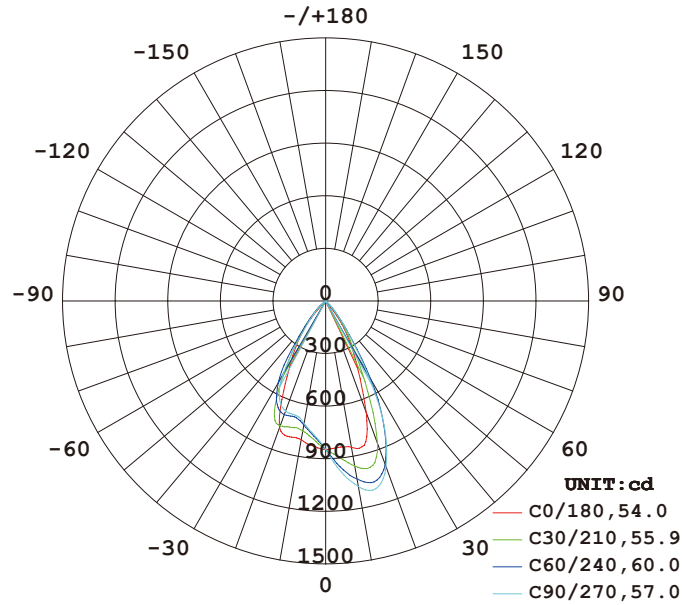

AVERAGE BEAM ANGLE (50%) : 56.7 DEG

Illuminance at a Distance

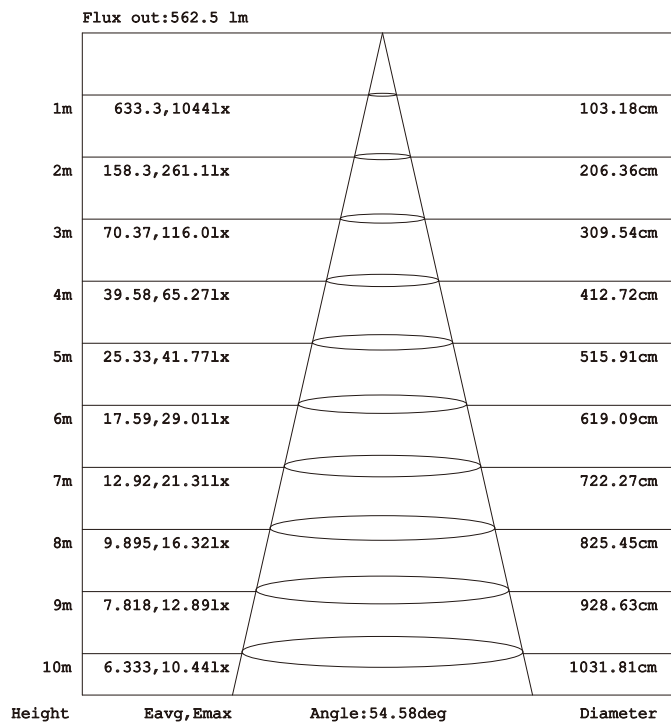

Model: NR-S35-DL105-10 60°

LUMINOUS INTENSITY DISTRIBUTION DIAGRAM

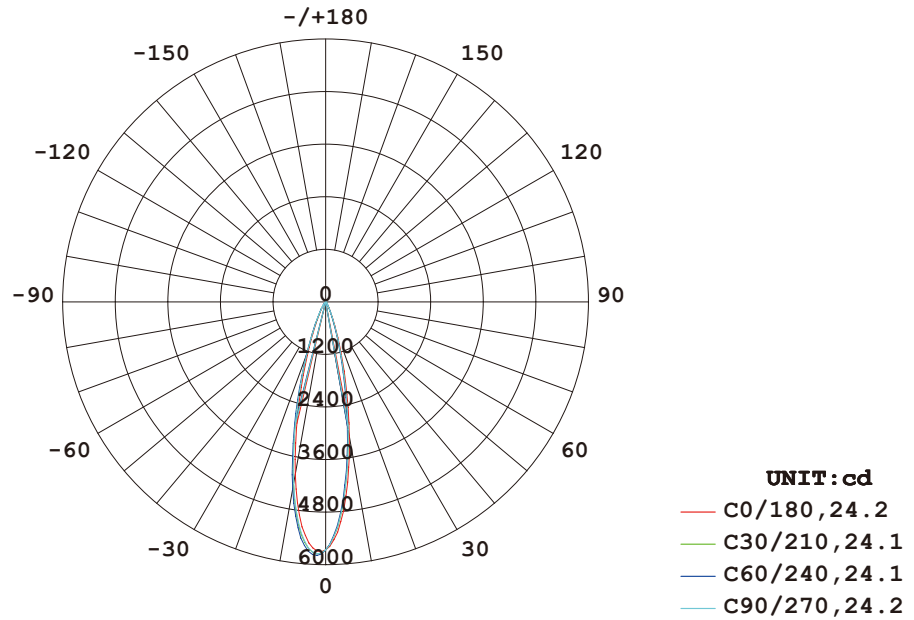

AVERAGE BEAM ANGLE (50%) : 24.2 DEG

Illuminance at a Distance

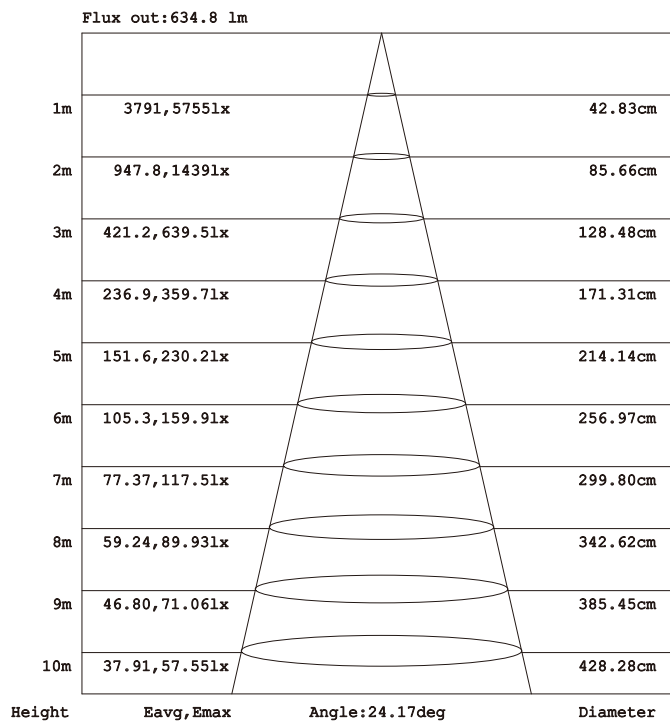

Model:NR-S35-DL105-15 24°

LUMINOUS INTENSITY DISTRIBUTION DIAGRAM

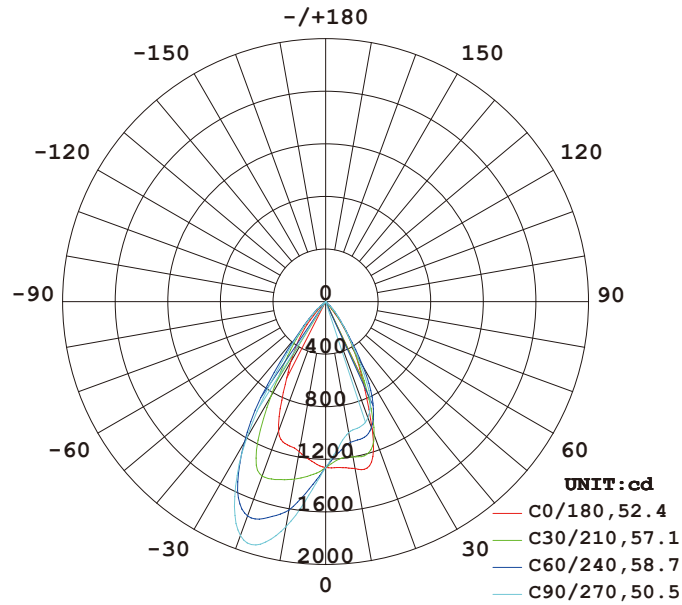

AVERAGE BEAM ANGLE (50%) : 54.7 DEG

Illuminance at a Distance

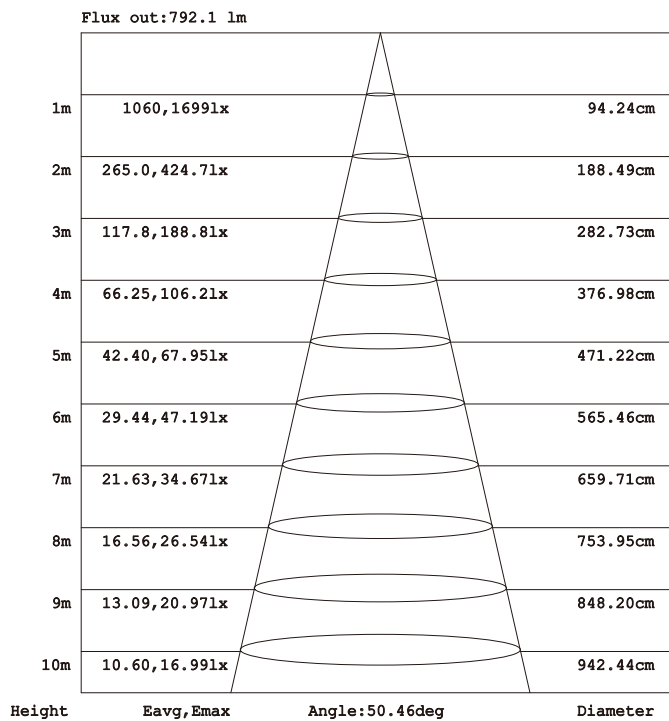

Model: NR-S35-DL105-15 60°

LUMINOUS INTENSITY DISTRIBUTION DIAGRAM

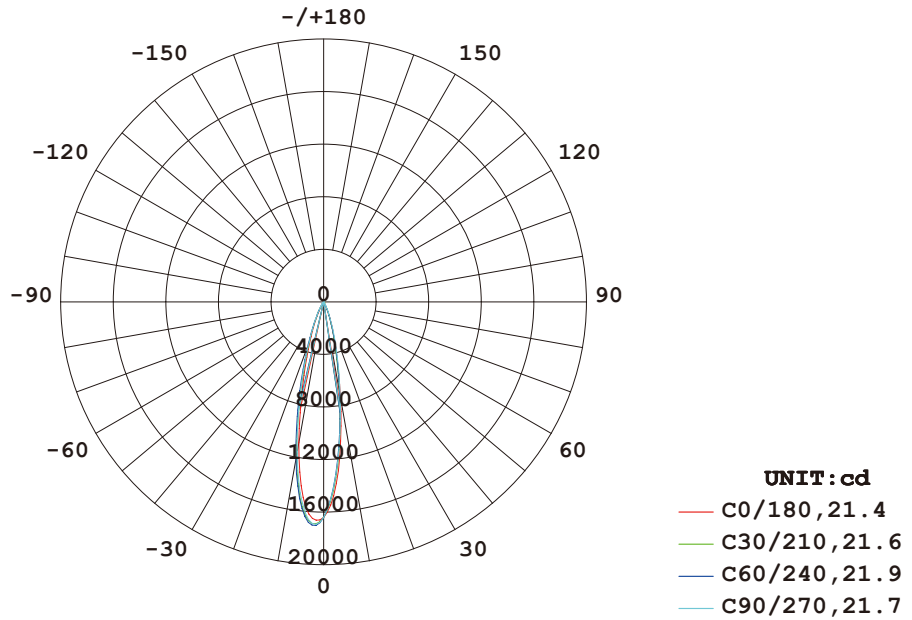

AVERAGE BEAM ANGLE (50%) : 21.6 DEG

Illuminance at a Distance

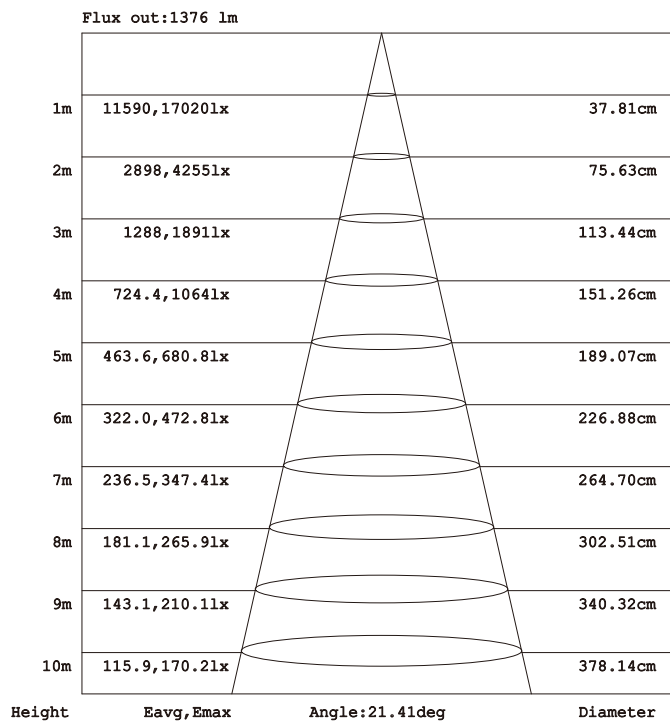

Model: NR-S35-DL105-30 24°

LUMINOUS INTENSITY DISTRIBUTION DIAGRAM

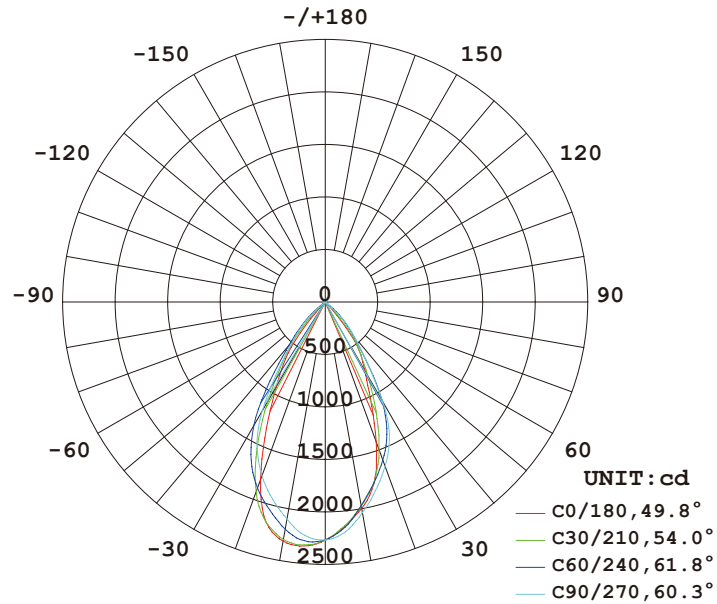

AVERAGE BEAM ANGLE (50%) : 56.5 DEG

Illuminance at a Distance

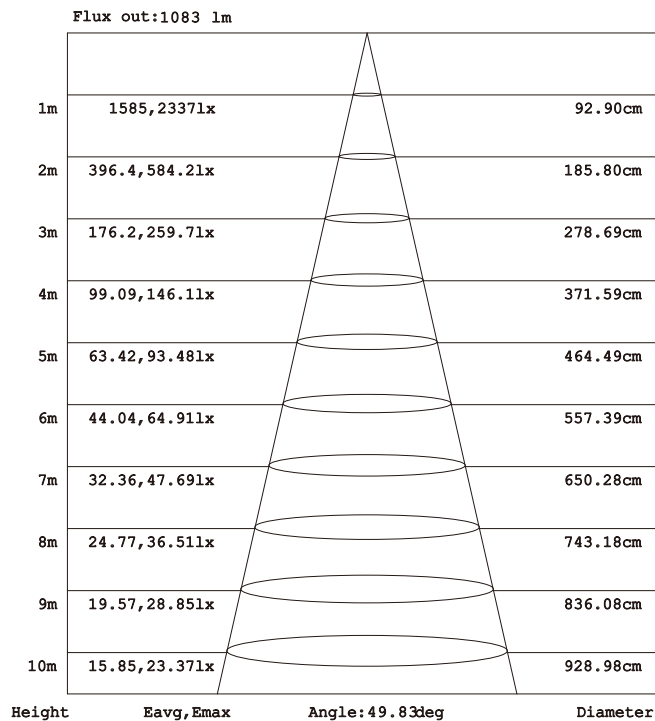

Model: NR-S35-DL105-30 60°

LUMINOUS INTENSITY DISTRIBUTION DIAGRAM

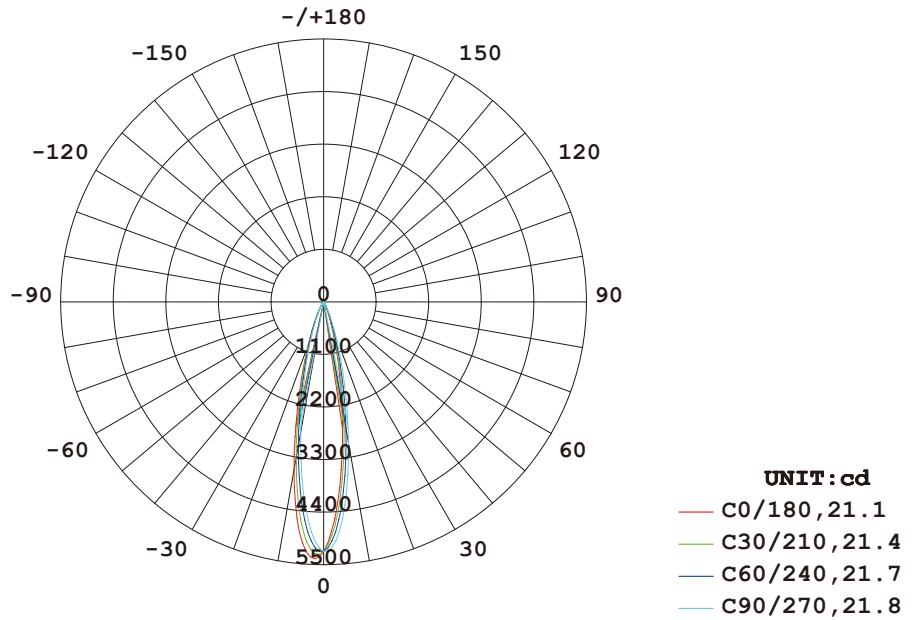

AVERAGE BEAM ANGLE (50%) : 21.5 DEG

Illuminance at a Distance

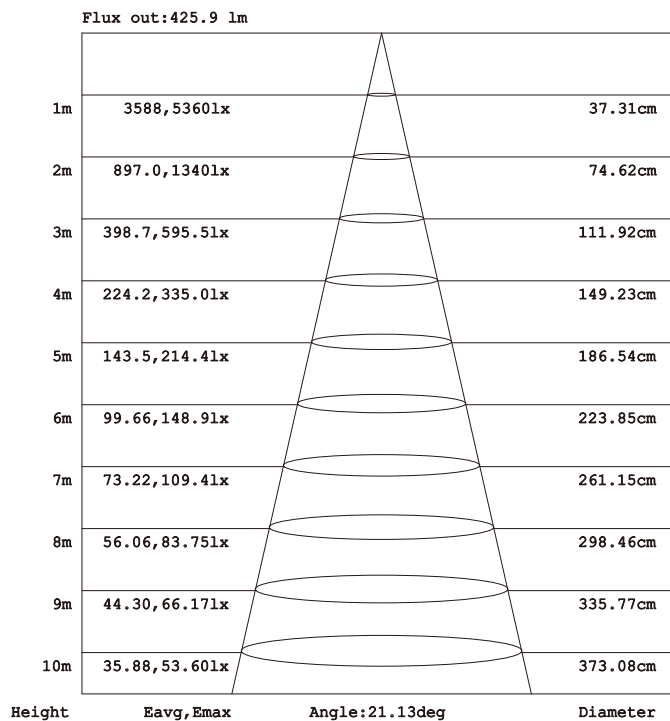

Model: NR-S20-DL105-10 24°

LUMINOUS INTENSITY DISTRIBUTION DIAGRAM

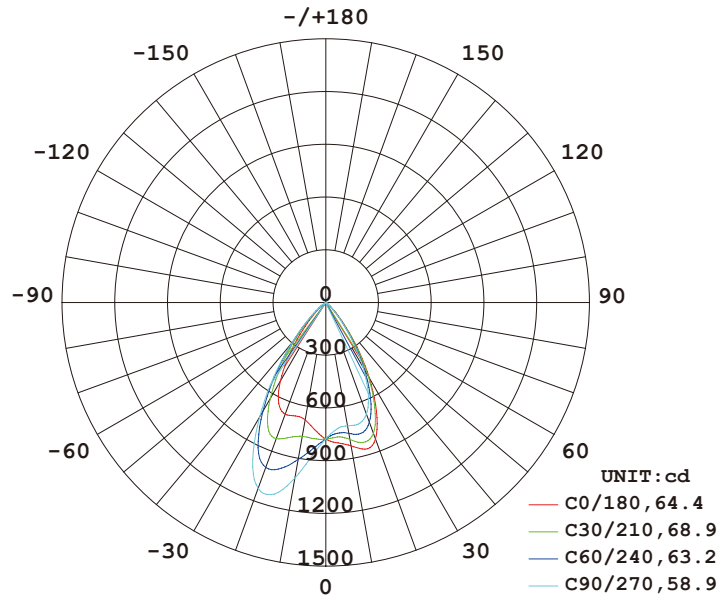

AVERAGE BEAM ANGLE (50%) : 63.9 DEG

Illuminance at a Distance

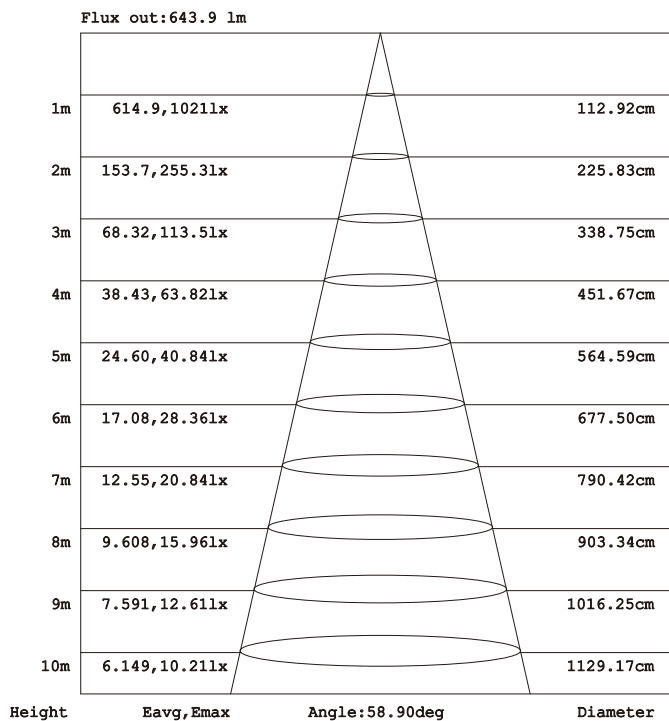

Model:NR-S20-DL105-10 60°

LUMINOUS INTENSITY DISTRIBUTION DIAGRAM

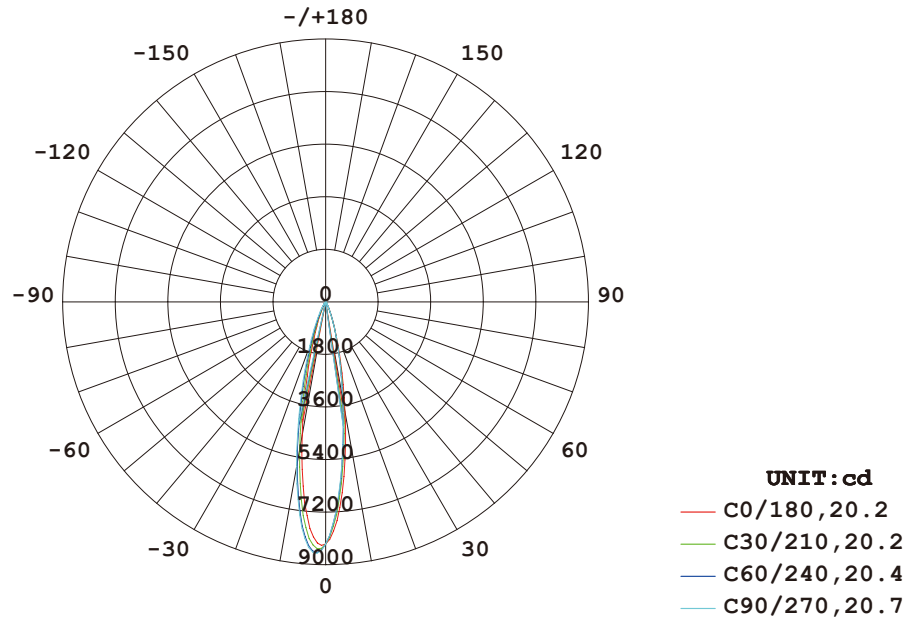

AVERAGE BEAM ANGLE (50%) : 20.4 DEG

Illuminance at a Distance

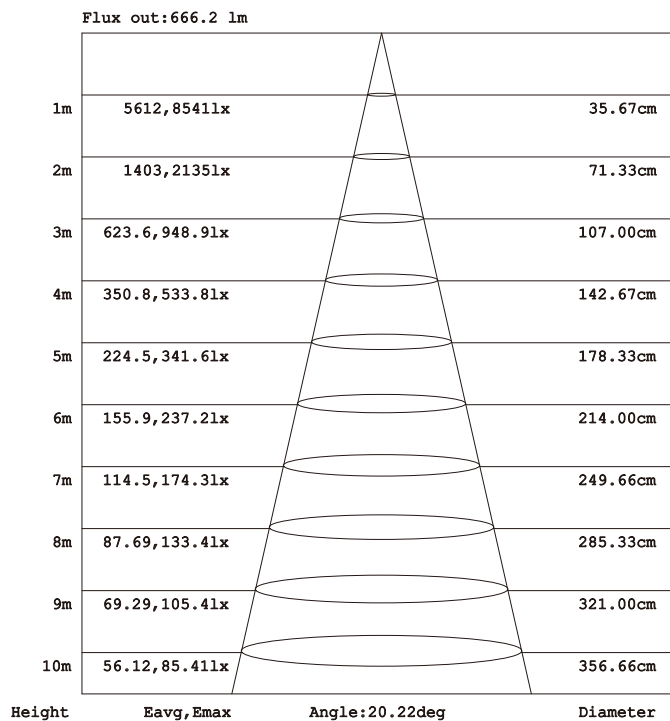

Model: NR-S20-DL105-15 24°

LUMINOUS INTENSITY DISTRIBUTION DIAGRAM

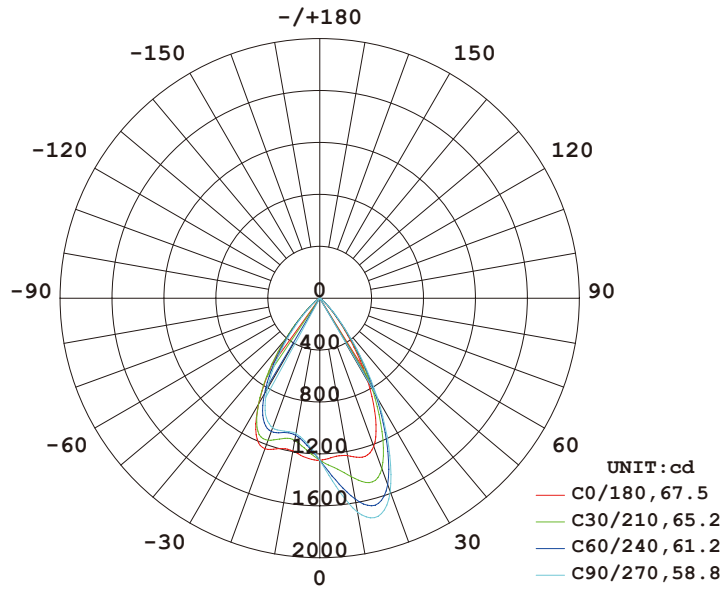

AVERAGE BEAM ANGLE (50%) : 63.2 DEG

Illuminance at a Distance

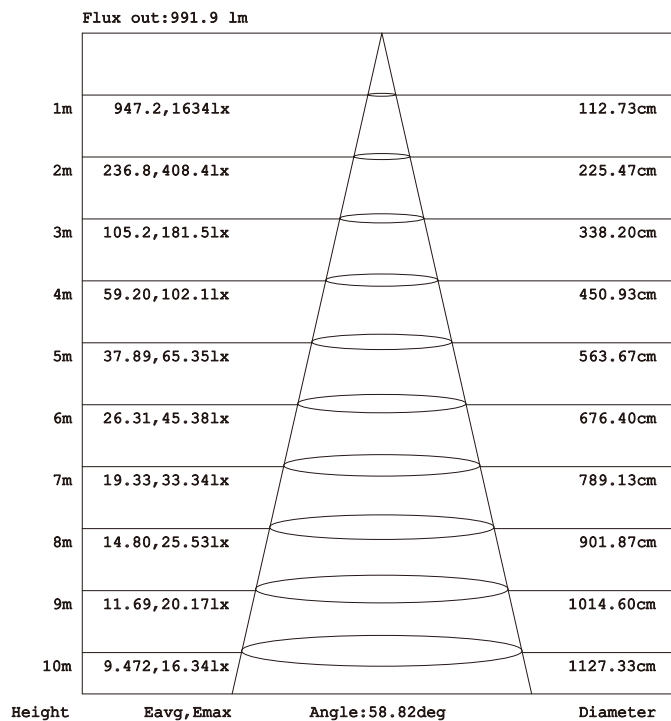

Model:NR-S20-DL105-15 60°

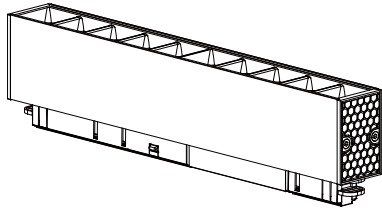

1

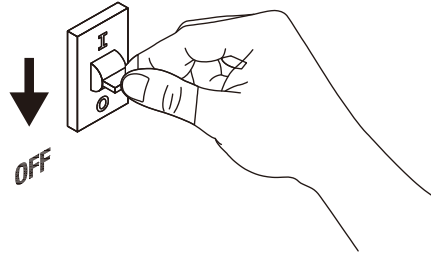
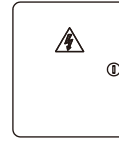
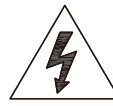

2

Turn off the power

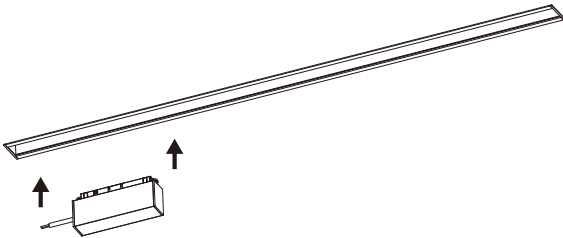

3

Install DC48V power supply

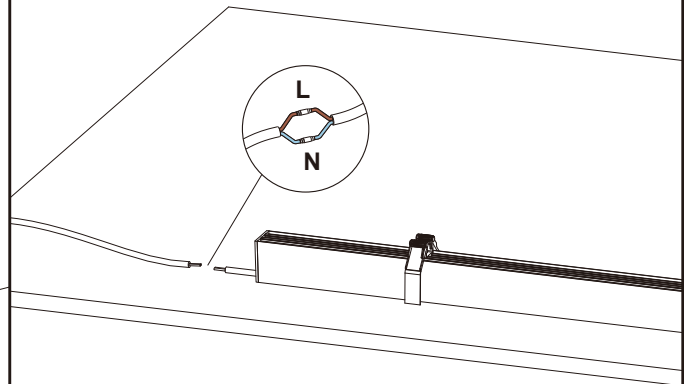

4

Connect the cable

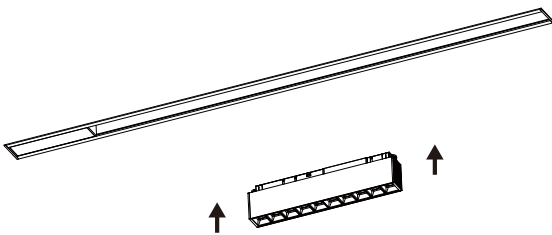

5

Install lamp

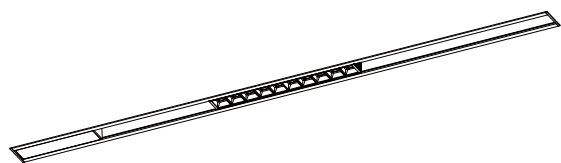

6

Installation is complete

