

LED DOWNLIGHT

NR-SLM101-7 Series
IP20

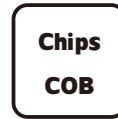
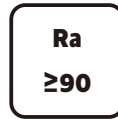

Item Code	P(W)	CCT(K)	Total Lumen	LM/W	Beam Angle	Dimensions in mm A	Dimensions in mm B	Hole Size (mm)	kg
NR-SLM101-7	7	3000/4000/6500	540	77.14	24°	50	55	70x70	0.11
NR-SLM101-7	7	3000/4000/6500	540	77.14	45°	50	55	70x70	0.11
NR-SLM101-10	10	3000/4000/6500	850	85	36°	53	66	70x70	0.17
NR-SLM101-15	15	3000/4000/6500	1200	80	36°	63	72	100x100	0.26

Dimensions in mm

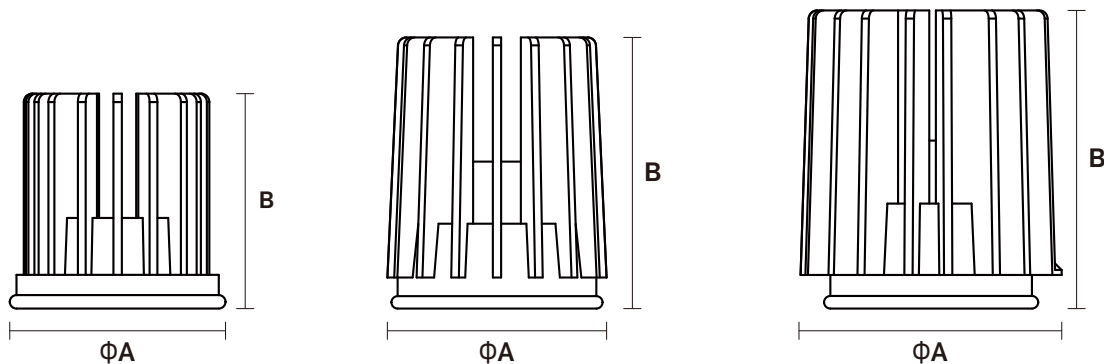



High quality aluminum shell



High quality COB light source



Description:

Recessed COB Downlight
Construction

Main material:

Die-cast aluminum+ glass cover+engineering plastic High quality aluminum spherical reflector for soft and comfortable light.

Specification:

Energy saving, up to 85% energy saving comparing to standard halogen and in candescent lamps Long life, up to 30,000 hours High quality light, High color rendering, less heat, no UV or IR radiation Build-in LED driver.

Applications

- .Shopping mall
- .Office buildings
- .Exhibition hall
- .Public lighting places

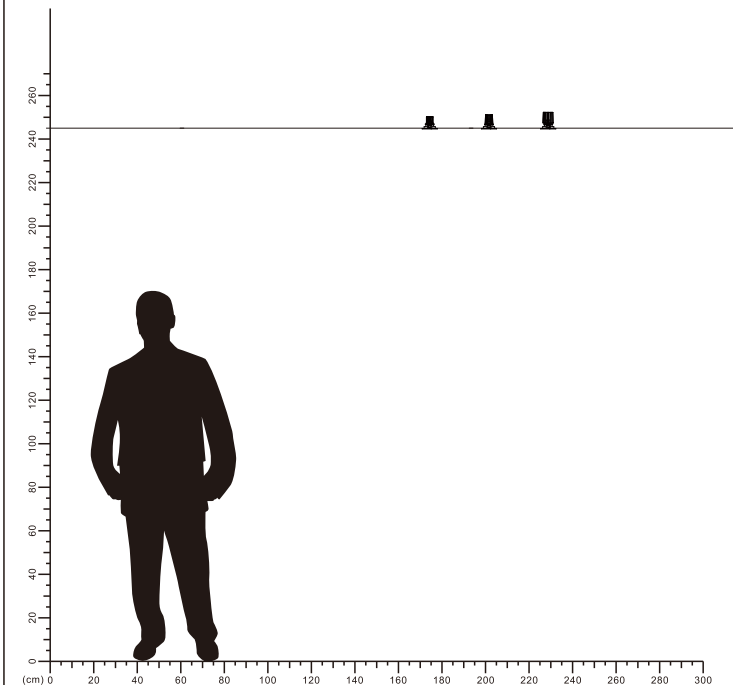

LUMINOUS INTENSITY DISTRIBUTION DIAGRAM

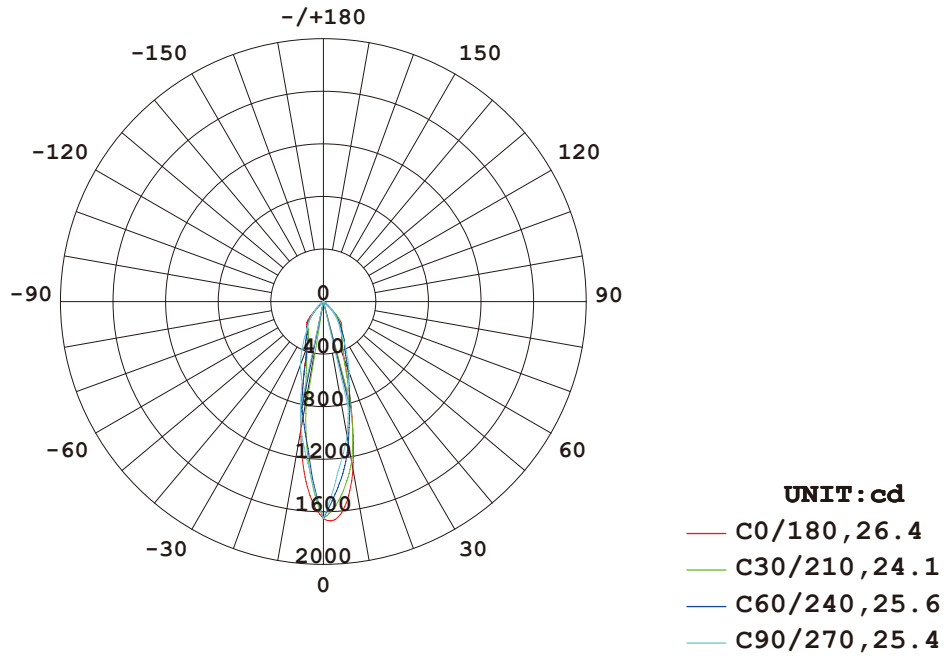

AVERAGE BEAM ANGLE (50%) : 25.4 DEG

Illuminance at a Distance

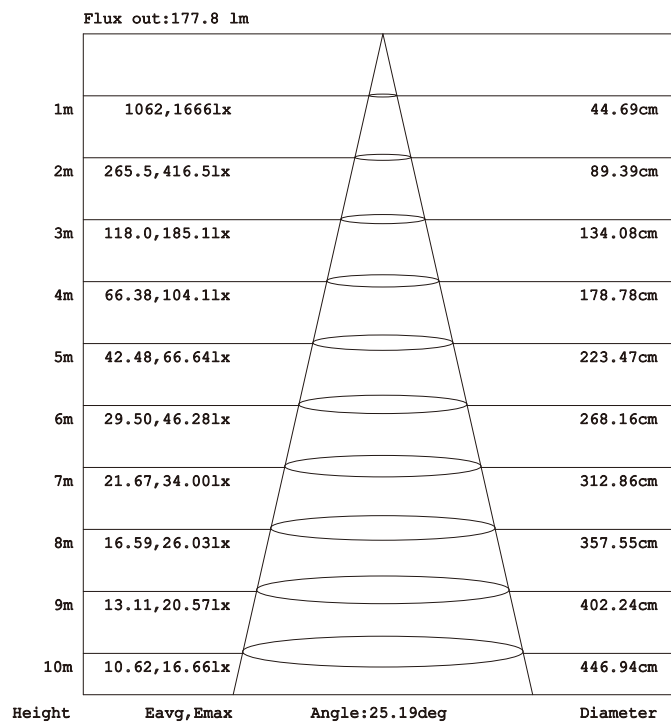

Model: NR-AL104WL-20

LUMINOUS INTENSITY DISTRIBUTION DIAGRAM

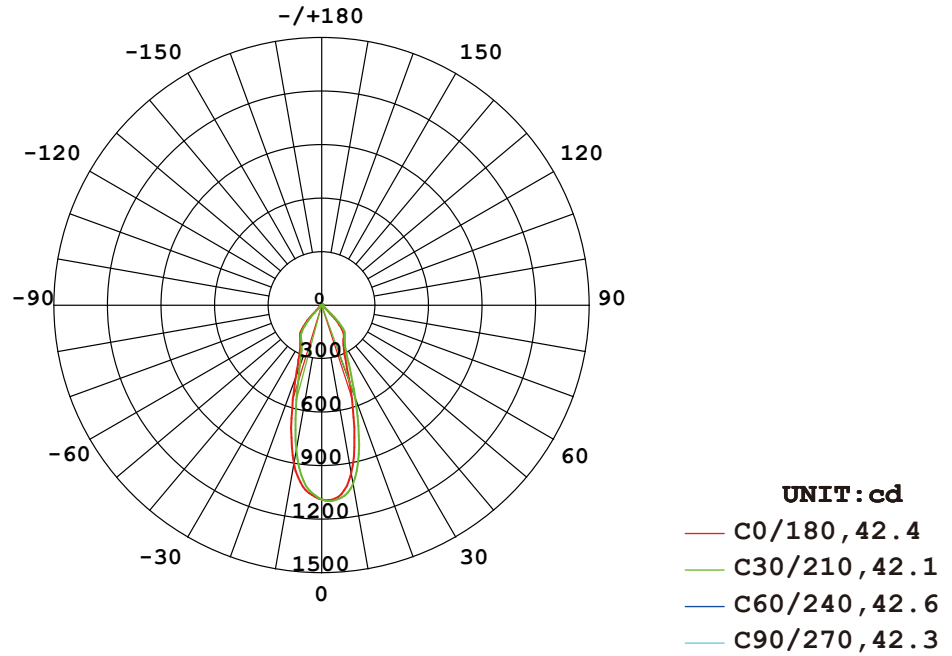

AVERAGE BEAM ANGLE (50%) : 42.4 DEG

Illuminance at a Distance

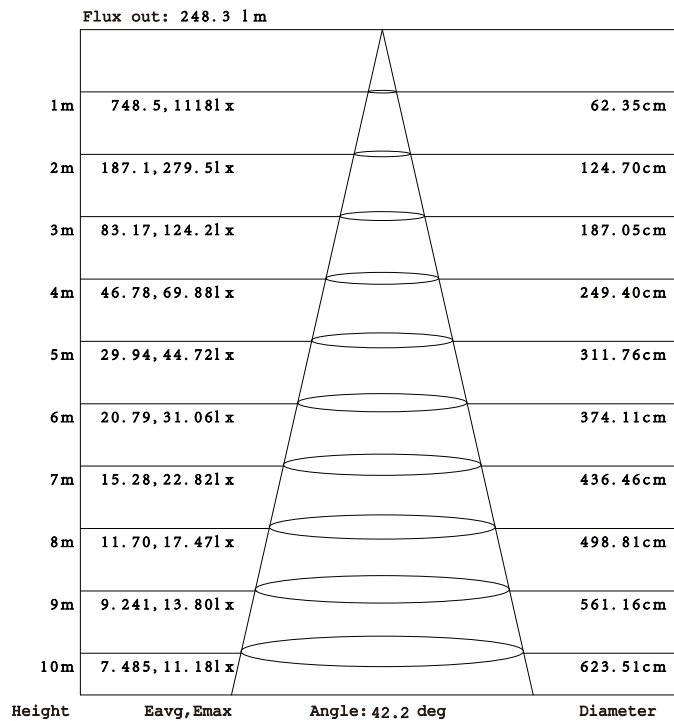

LUMINOUS INTENSITY DISTRIBUTION DIAGRAM

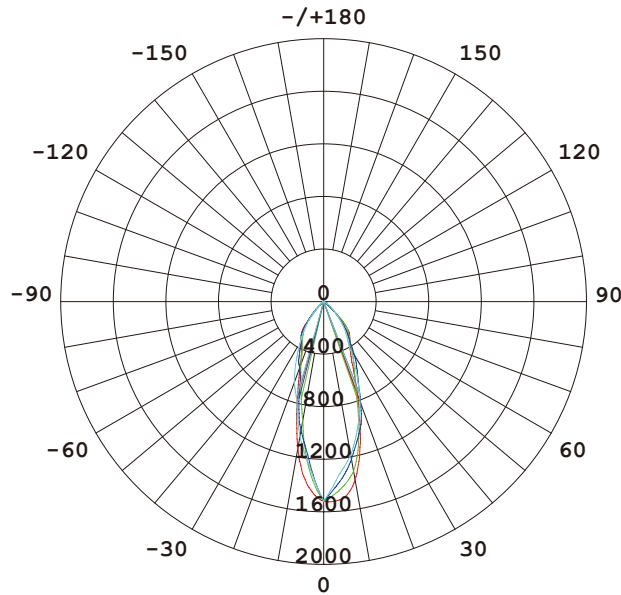

- UNIT : cd**
- C0/180 , 35.2
 - C30/210 , 32.2
 - C60/240 , 35.6
 - C90/270 , 36.9

AVERAGE BEAM ANGLE (50%) : 35 DEG

Illuminance at a Distance

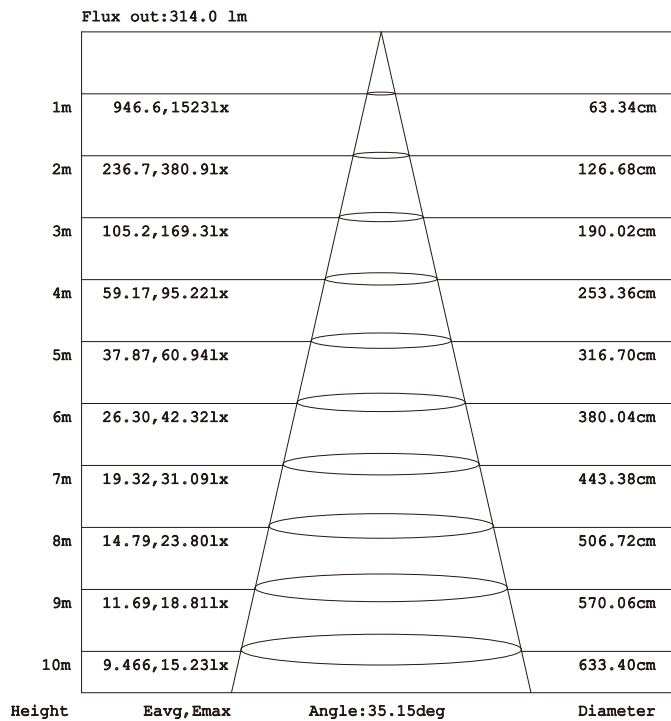

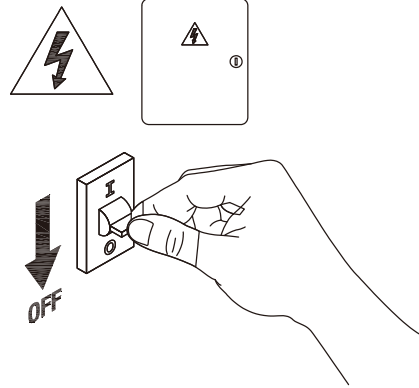
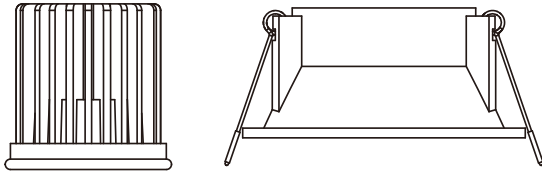

1

Turn off The Power

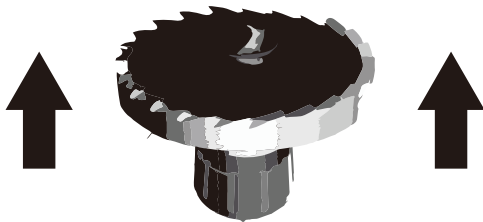

2

Cut a hole on your ceiling

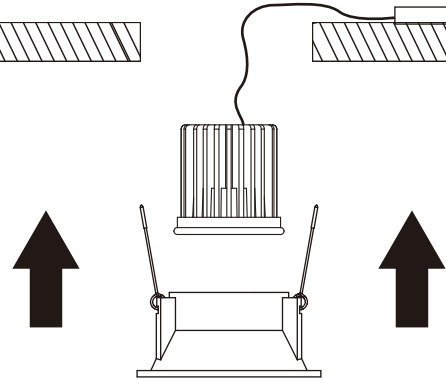

3

Install lamps and wiring

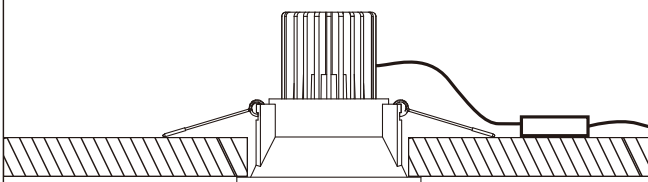

4

Installation complete

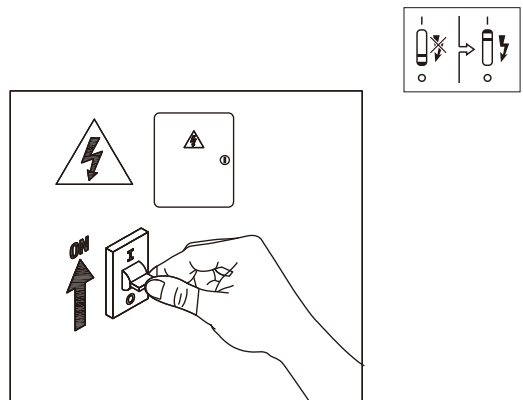

Turn on the power

