

## LED Wall Wash Lamp

NR-WS102-ANTI Series  
IP65

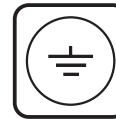
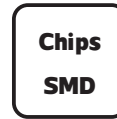
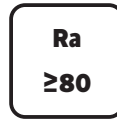

Item Code	P(W)	CCT(K)	Total Lumen	LM/W	Beam Angle	Dimensions in mm			kg
						A	B	C	
NR-WS102-ANTI-12	12	3000/4000/6500	900	75	24°	400	46	38	0.91
NR-WS102-ANTI-24	24	3000/4000/6500	1920	80	24°	800	46	38	1.51
NR-WS102-ANTI-36	36	3000/4000/6500	2880	80	24°	1200	46	38	2.15
NR-WS102-ANTI-70	70	3000/4000/6500	5110	73	36°	1200	46	38	2.15

### Dimensions in mm

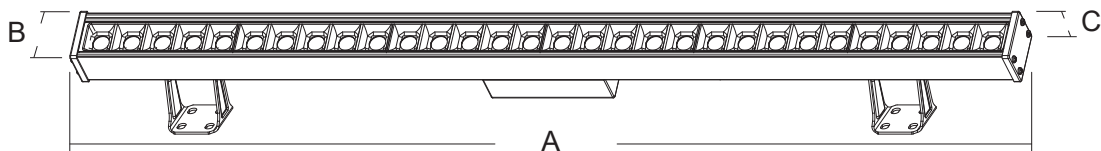

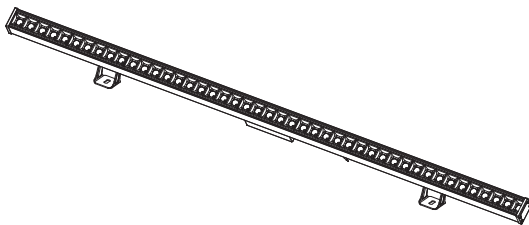

**Description:**

LED Wall Wash Lamp

**Main material:**

Die-cast aluminum+ glass cover

**Specification:**

Energy saving, up to 85% energy saving comparing to standard halogen and in candescent lamps Long life, up to 30,000 hours High quality light, High color rendering, less heat, no UV or IR radiation Build-in LED driver.

**Applications**

- .Lawn
- .Garden
- .Building external wall

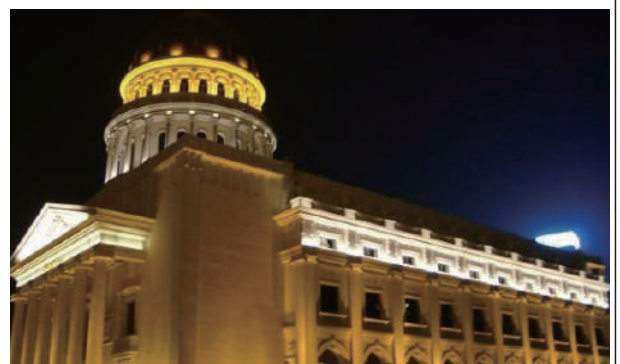
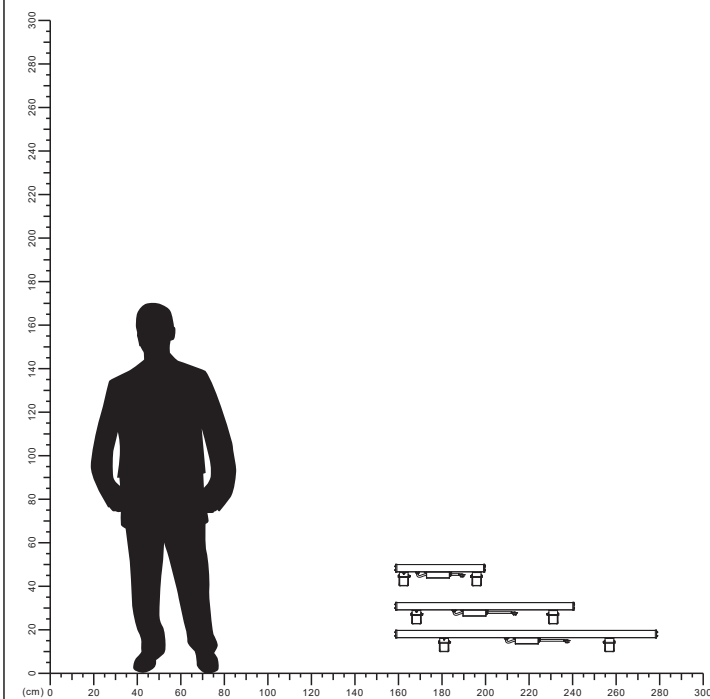

# LUMINOUS INTENSITY DISTRIBUTION DIAGRAM

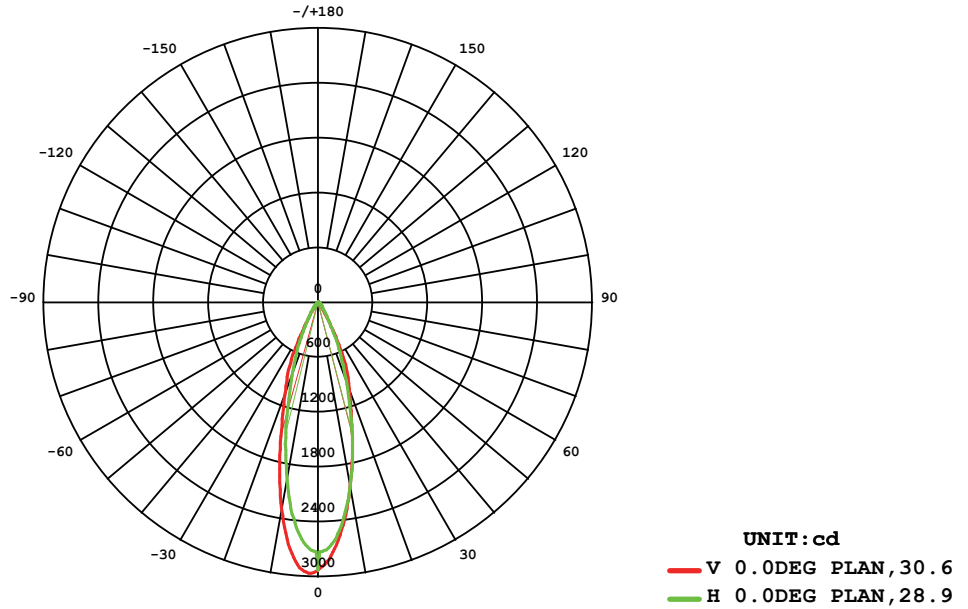

**AVERAGE BEAM ANGLE (50%) : 29.7 DEG**

## Illuminance at a Distance

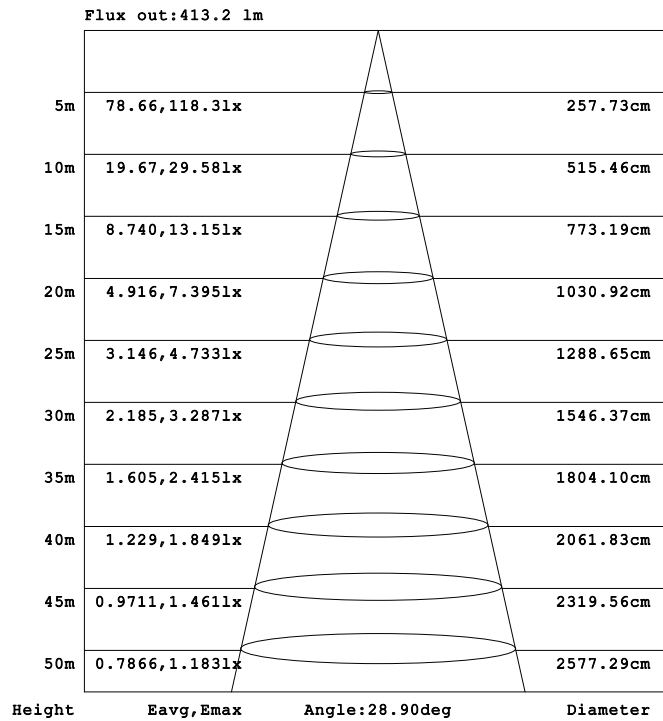

Model:NR-WS102-ANTI-12

# LUMINOUS INTENSITY DISTRIBUTION DIAGRAM

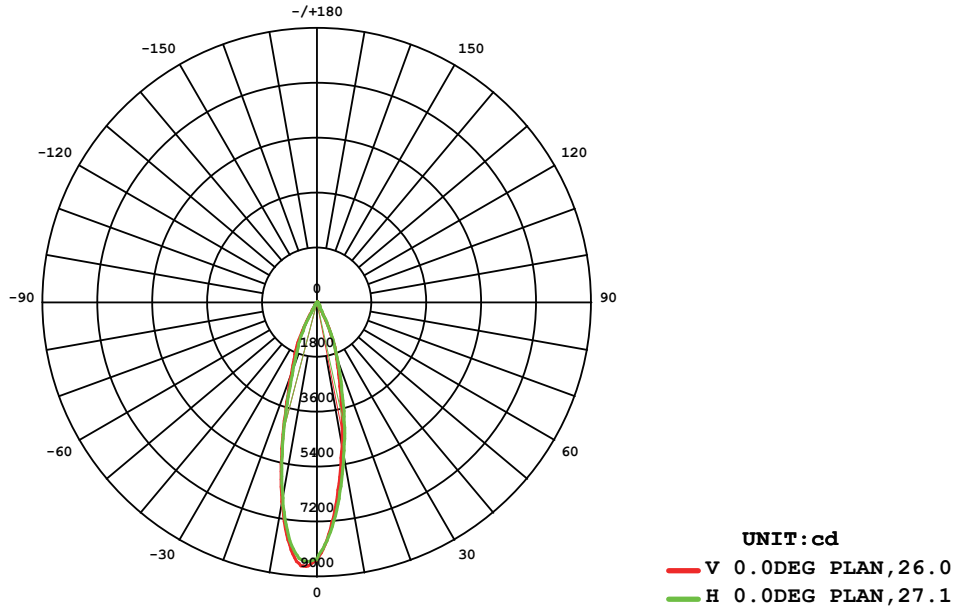

**AVERAGE BEAM ANGLE (50%) : 26.6 DEG**

## Illuminance at a Distance

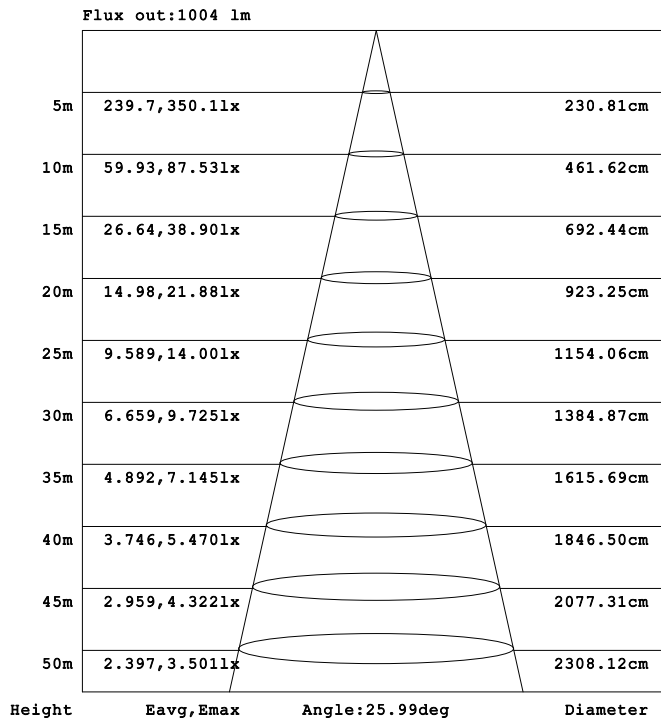

Model: NR-WS102-ANTI-24

# LUMINOUS INTENSITY DISTRIBUTION DIAGRAM

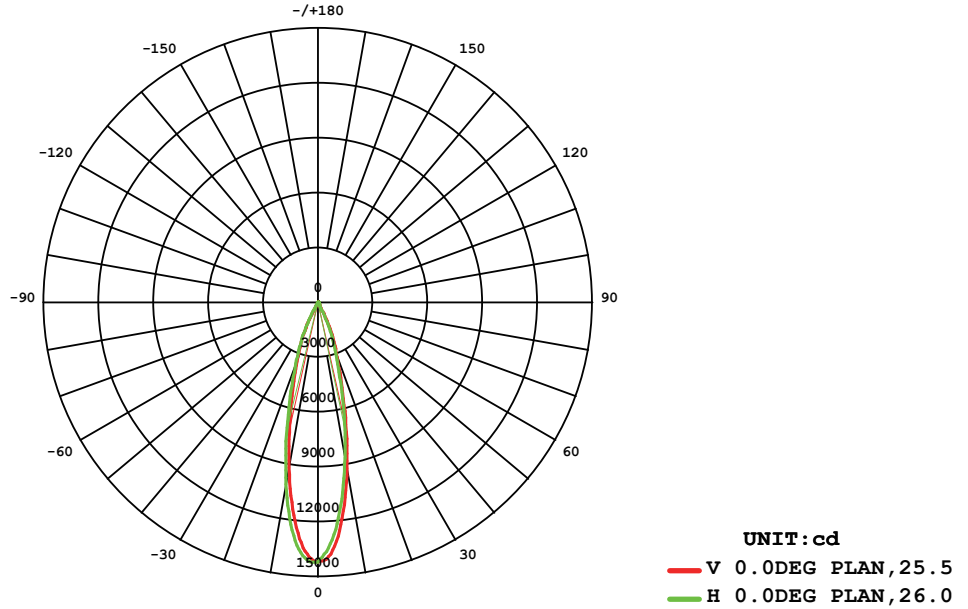

**AVERAGE BEAM ANGLE (50%) : 25.8 DEG**

## Illuminance at a Distance

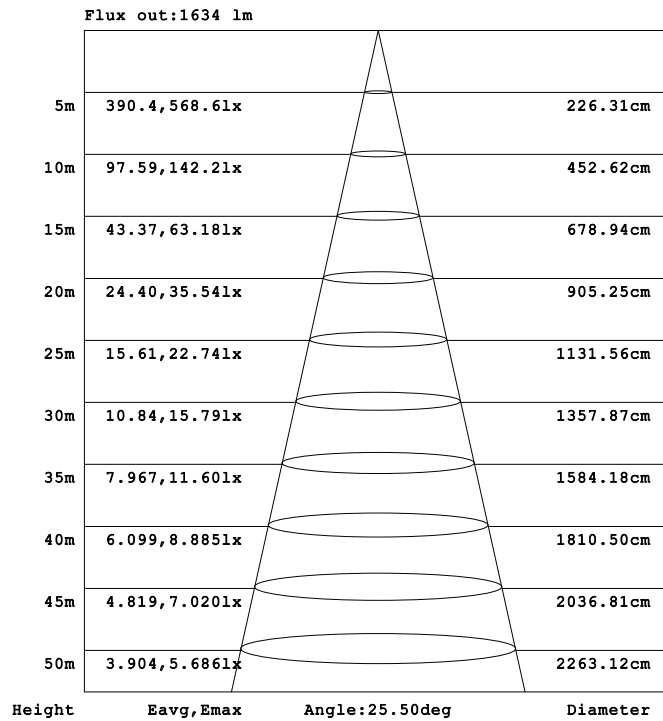

**Model: NR-WS102-ANTI-36**

# LUMINOUS INTENSITY DISTRIBUTION DIAGRAM

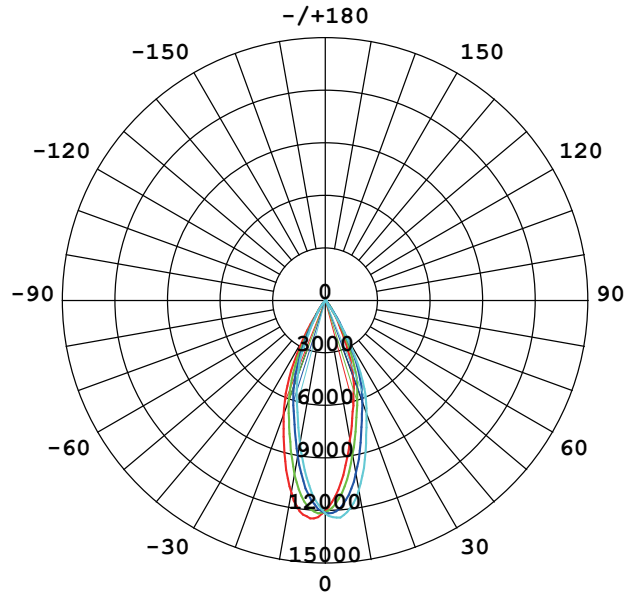

- UNIT: cd**
- C0/180, 36.8
  - C30/210, 37.6
  - C60/240, 38.0
  - C90/270, 37.3

**AVERAGE BEAM ANGLE (50%) : 37.5 DEG**

## Illuminance at a Distance

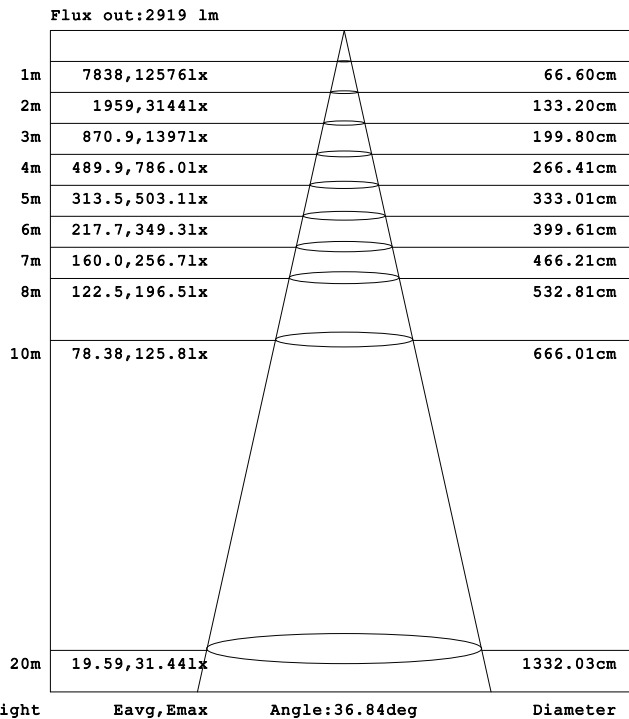

**Model:NR-WS102-ANTI-70**

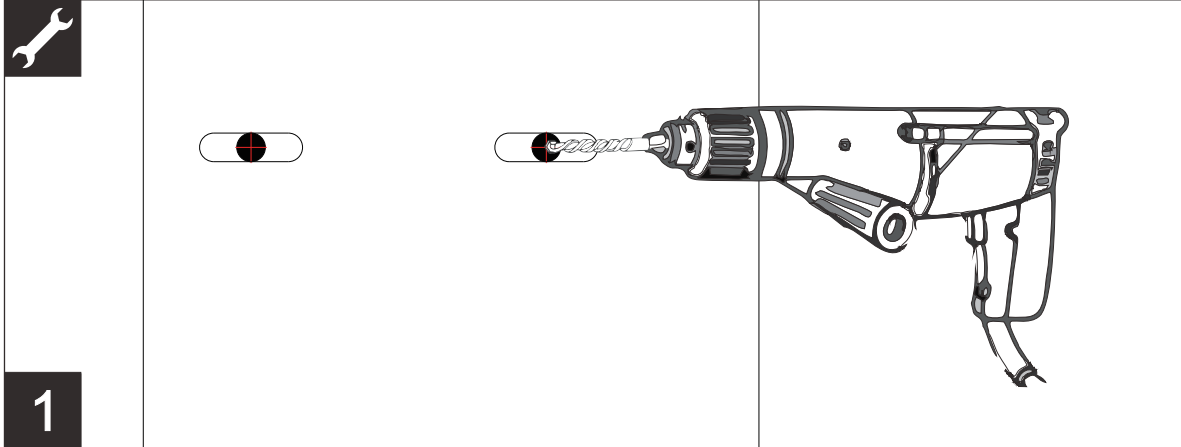

1

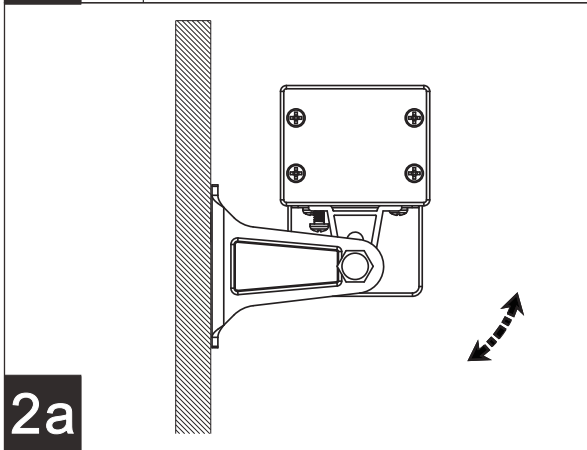

2a

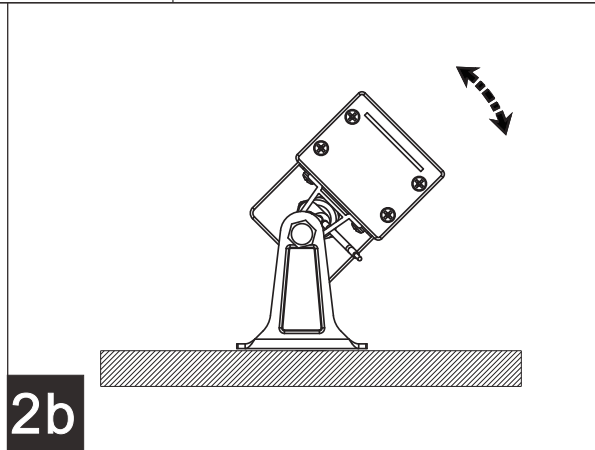

2b

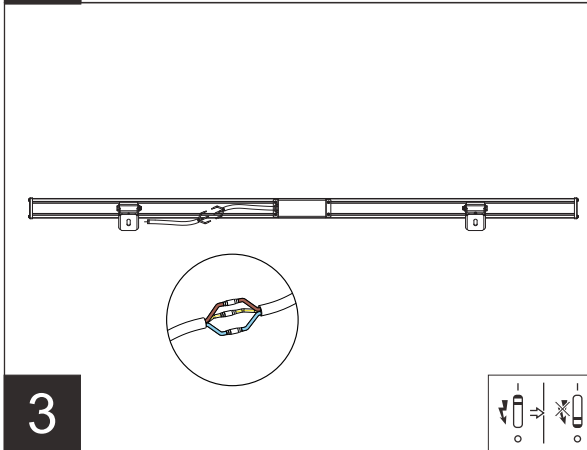

3

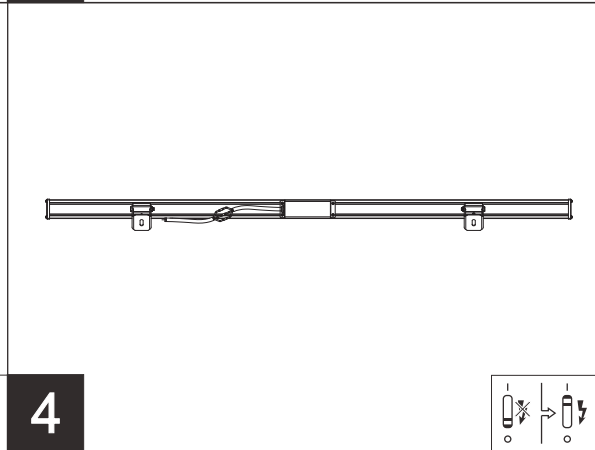

4

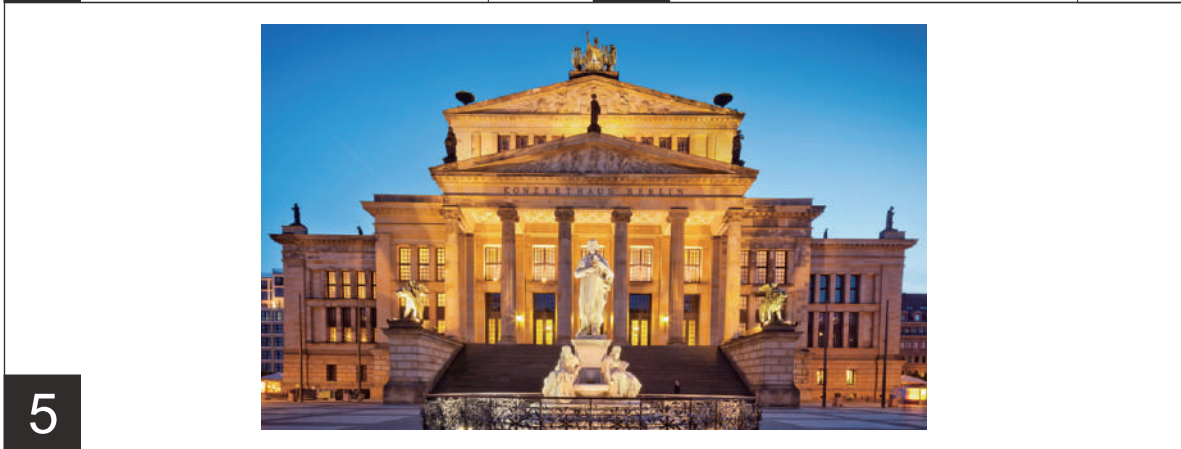

5

