

LED Magnetic Track System

NR-ZD105 Series
IP20

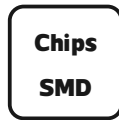
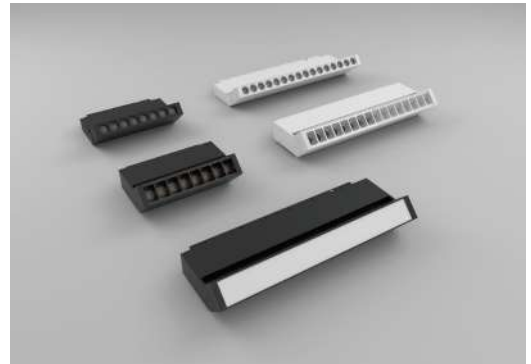

Item Code	P(W)	Using Track	Total Lumen	Beam Angle	Dimensions in mm			kg
					A	B	C	
NR-S20-ZD105-6	6	NR-S20	426	24°/60°	158	24	138	0.38
NR-S20-ZD105-10	10	NR-S20	710	24°/60°	305	24	138	0.60
NR-S35-ZD105-6	6	NR-S35	426	24°/60°	159	34	120	0.31
NR-S35-ZD105-10	10	NR-S35	710	24°/60°	302	34	120	0.60
NR-S35-ZP105-10	10	NR-S35	710	100°	302	34	120	0.60

Dimensions in mm

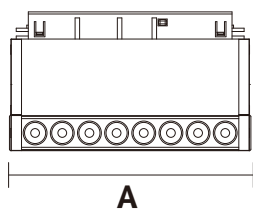

NR-S20-ZD105-6

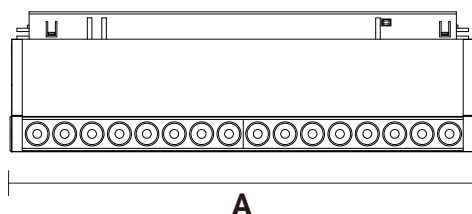
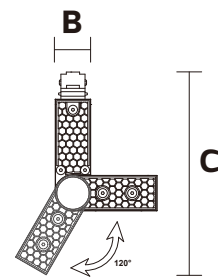

NR-S20-ZD105-10

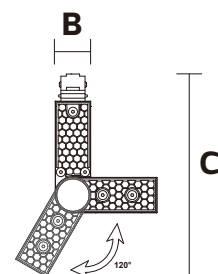

Dimensions in mm

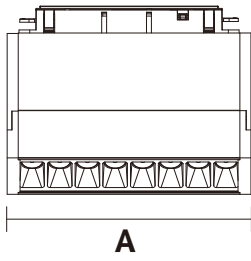

NR-S35-ZD105-6

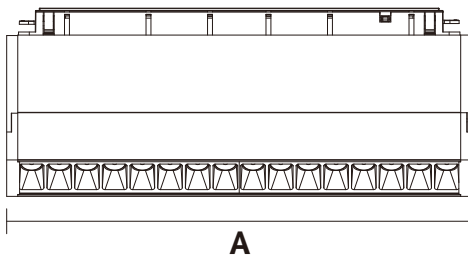
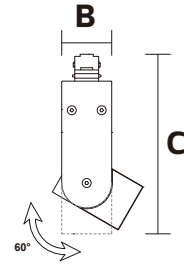

NR-S35-ZD105-10

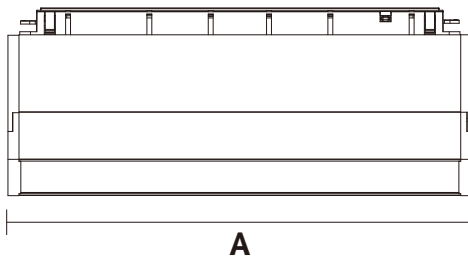
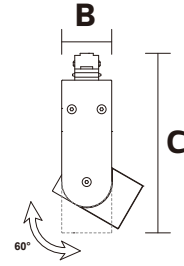

NR-S35-ZP105-10

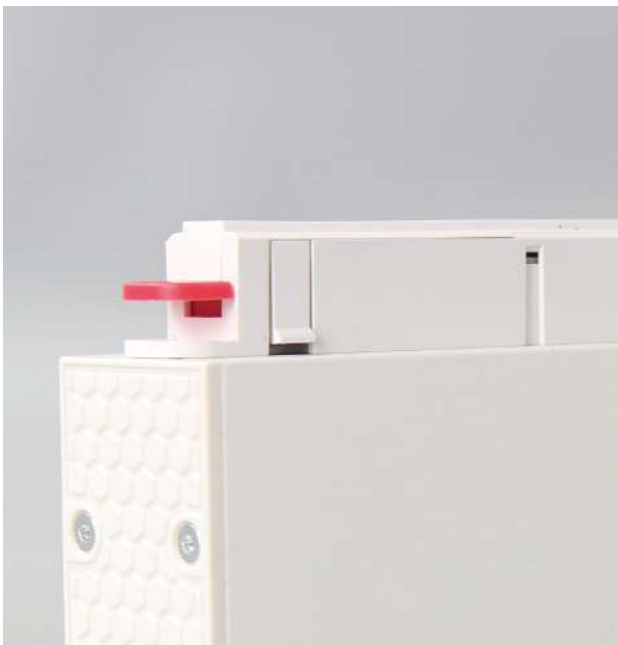
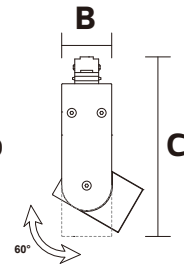

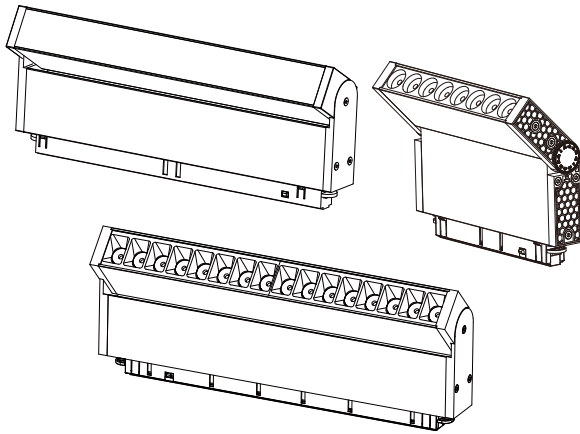

Description:
LED Magnetic Track System

Main material:
Aluminum shell, Silica gel

Specification:
Energy saving, up to 85% energy saving comparing to standard halogen and incandescent lamps
High quality light, high color rendering, less heat, no UV or IR radiation
Build-in LED Driver

Applications
.Office
.Meeting room
.Sitting room

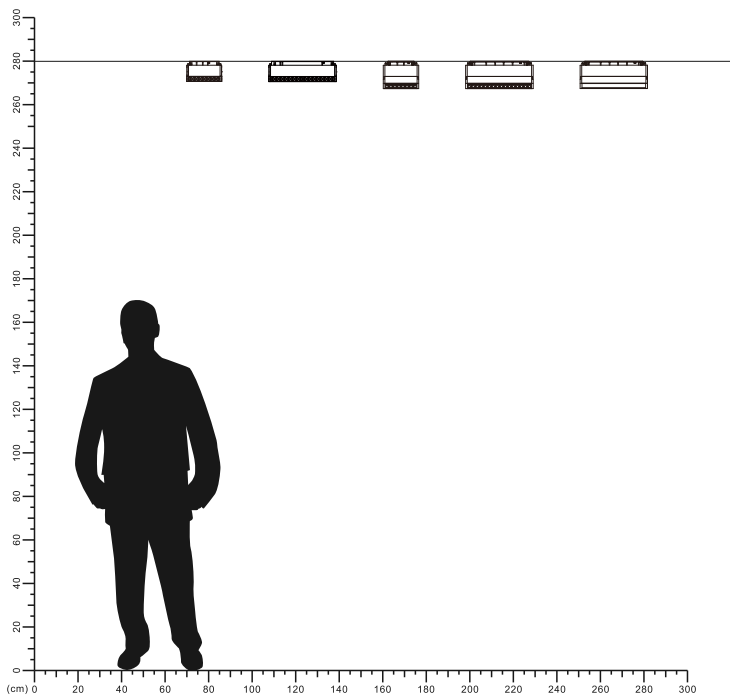

LUMINOUS INTENSITY DISTRIBUTION DIAGRAM

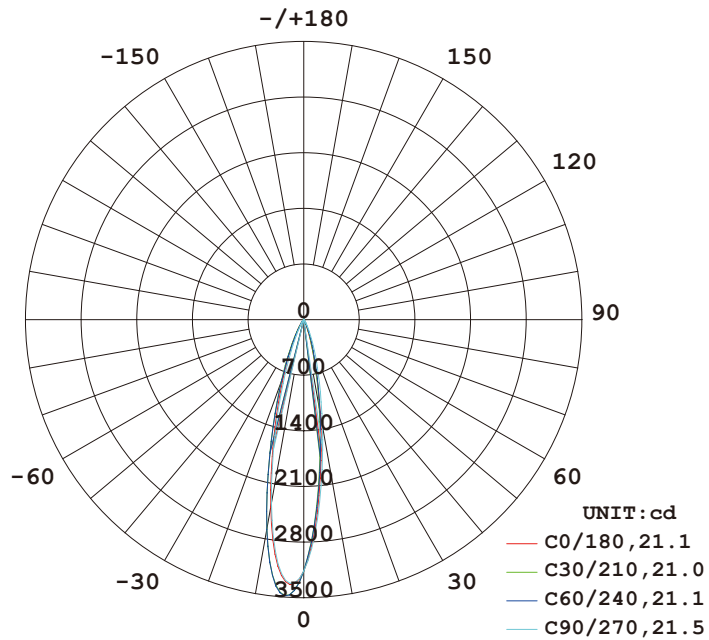

AVERAGE BEAM ANGLE (50%) : 21.2 DEG

Illuminance at a Distance

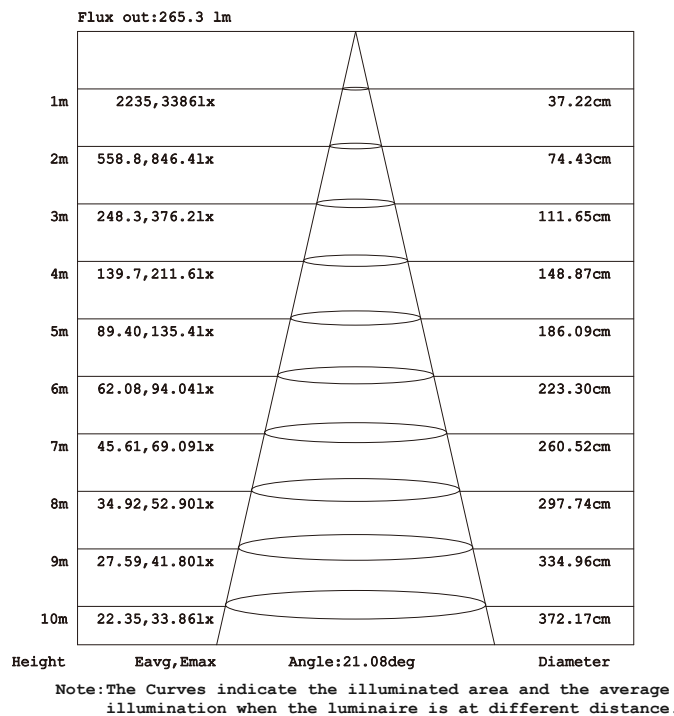

Model: NR-S20-ZD105-6 24°

LUMINOUS INTENSITY DISTRIBUTION DIAGRAM

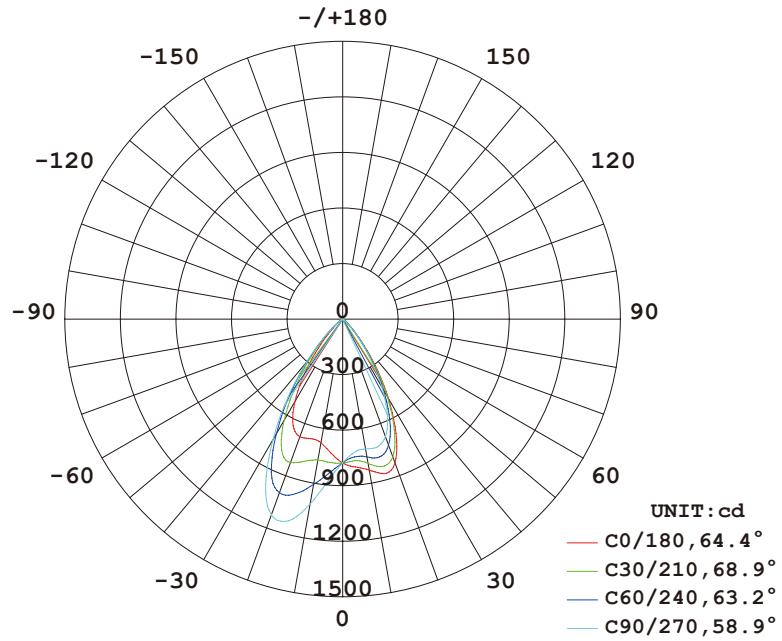

AVERAGE BEAM ANGLE (50%) : 63.9 DEG

Illuminance at a Distance

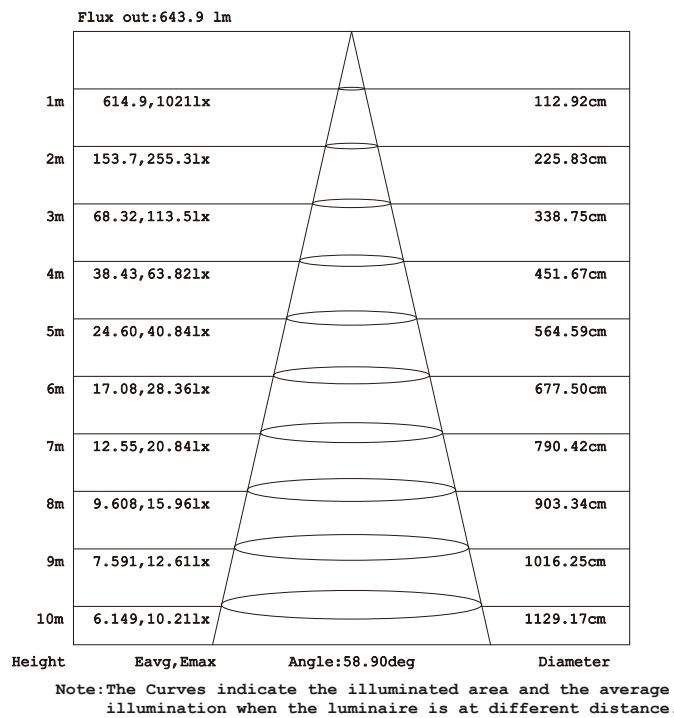

Model: NR-S20-ZD105-6 60°

LUMINOUS INTENSITY DISTRIBUTION DIAGRAM

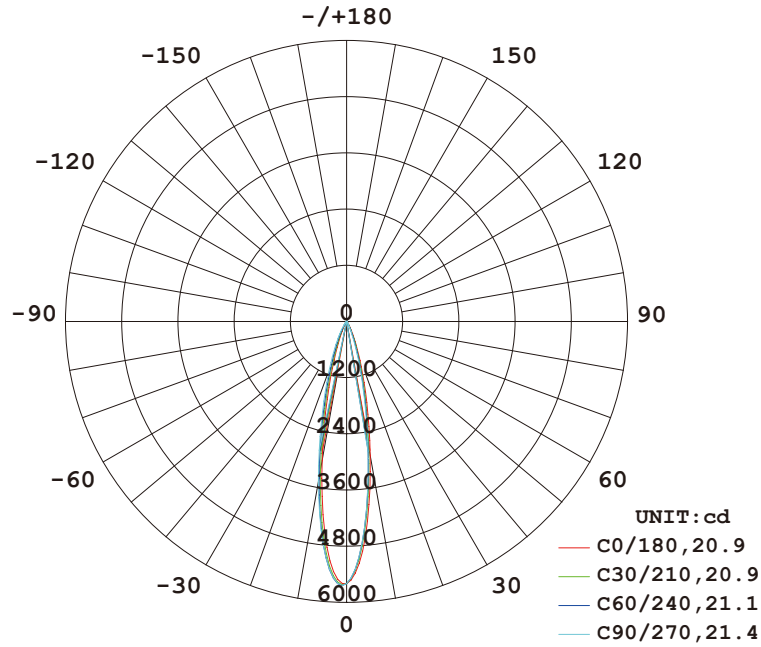

AVERAGE BEAM ANGLE (50%) : 21.1 DEG

Illuminance at a Distance

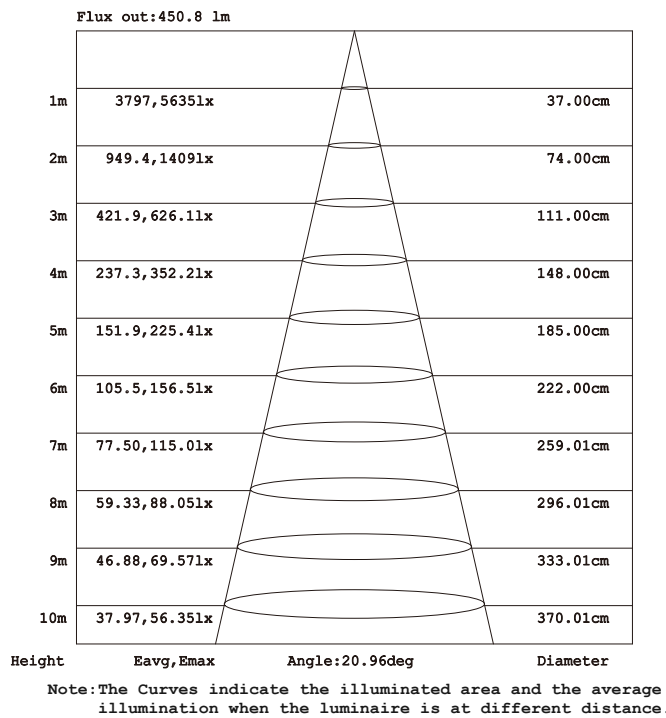

Model: NR-S20-ZD105-10 24°

LUMINOUS INTENSITY DISTRIBUTION DIAGRAM

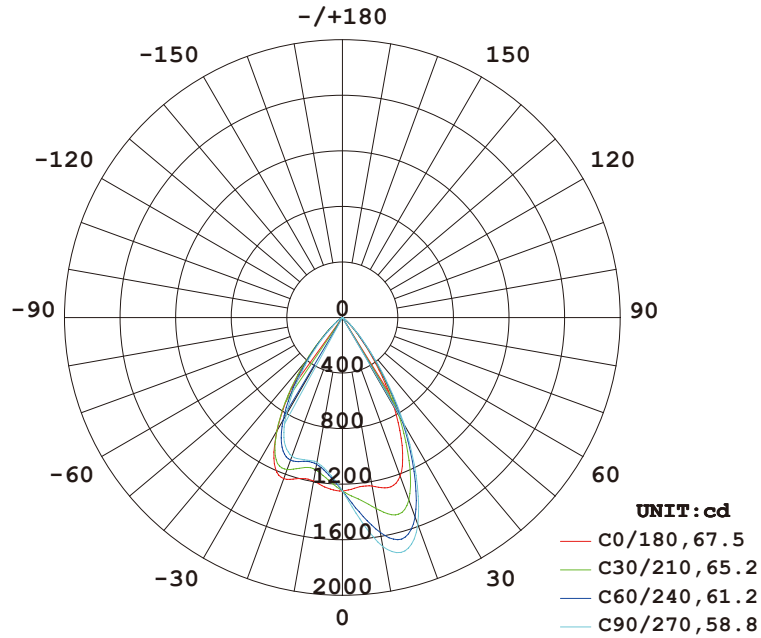

AVERAGE BEAM ANGLE (50%) : 63.2 DEG

Illuminance at a Distance

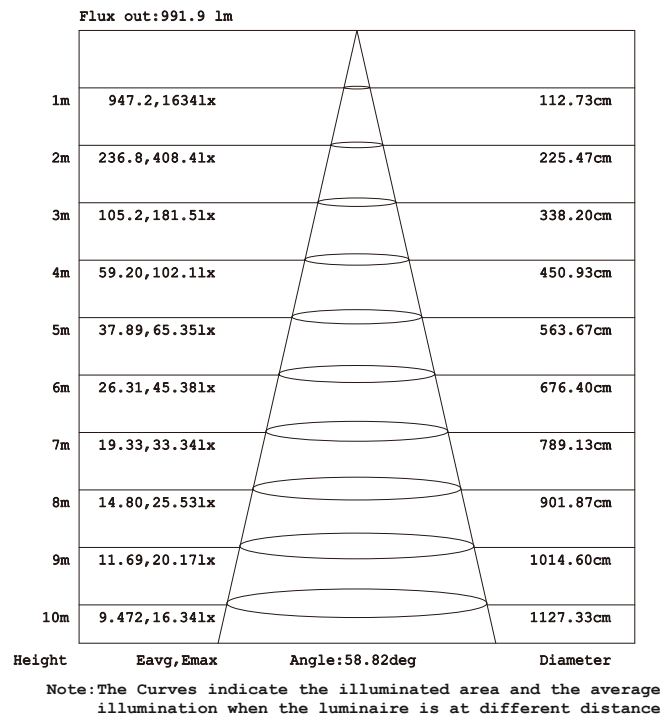

Model:NR-S20-ZD105-10 60°

LUMINOUS INTENSITY DISTRIBUTION DIAGRAM

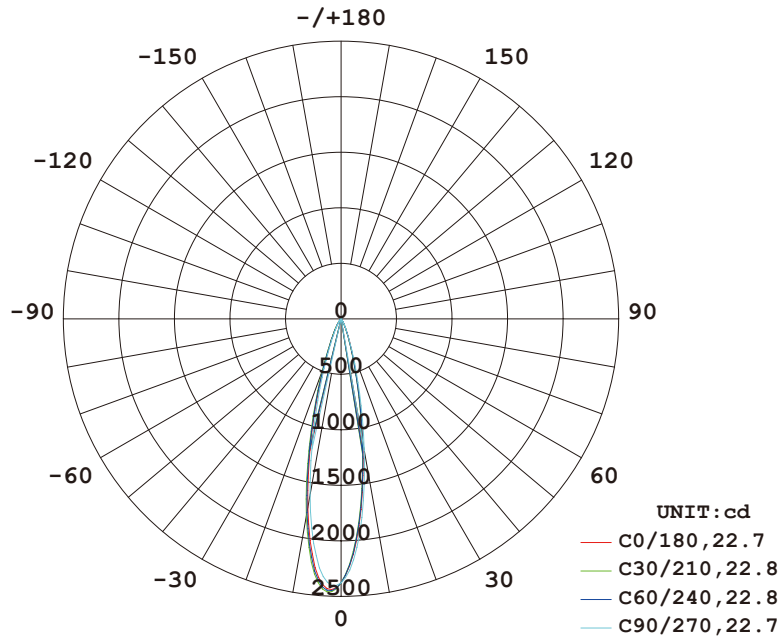

AVERAGE BEAM ANGLE (50%) : 22.7 DEG

Illuminance at a Distance

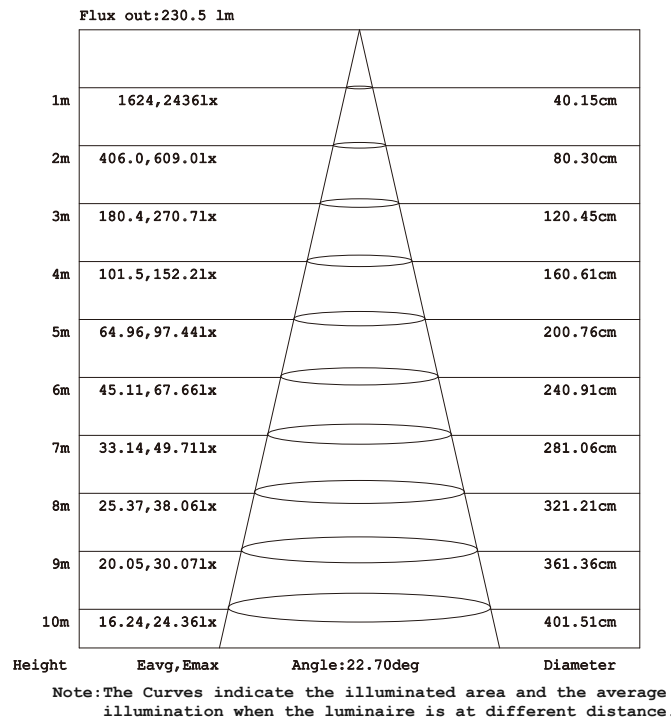

Model: NR-S35-ZD105-6 24°

LUMINOUS INTENSITY DISTRIBUTION DIAGRAM

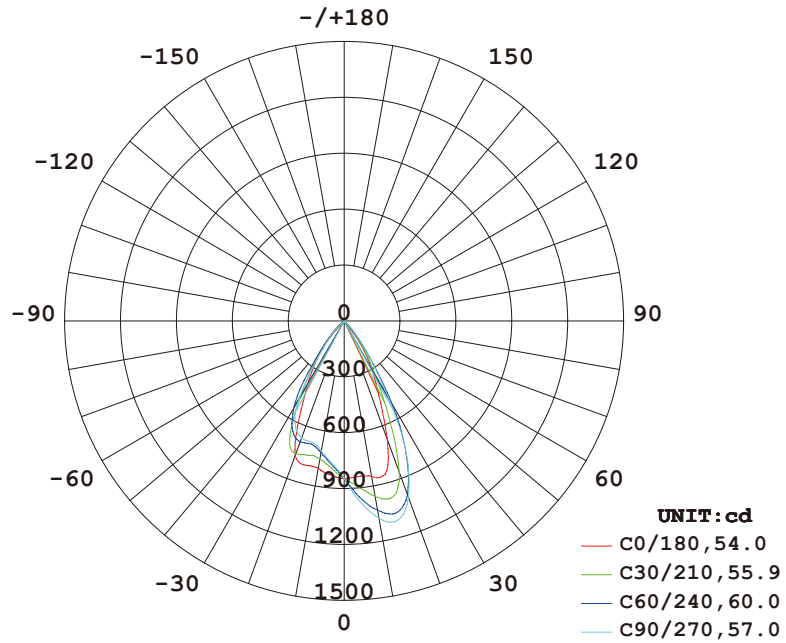

AVERAGE BEAM ANGLE (50%) : 56.7 DEG

Illuminance at a Distance

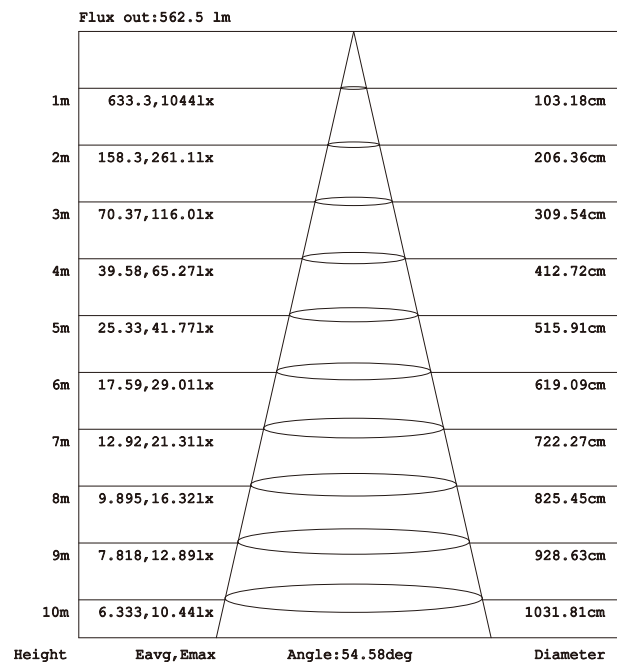

Note: The Curves indicate the illuminated area and the average illumination when the luminaire is at different distance.

Model: NR-S35-ZD105-6 60°

LUMINOUS INTENSITY DISTRIBUTION DIAGRAM

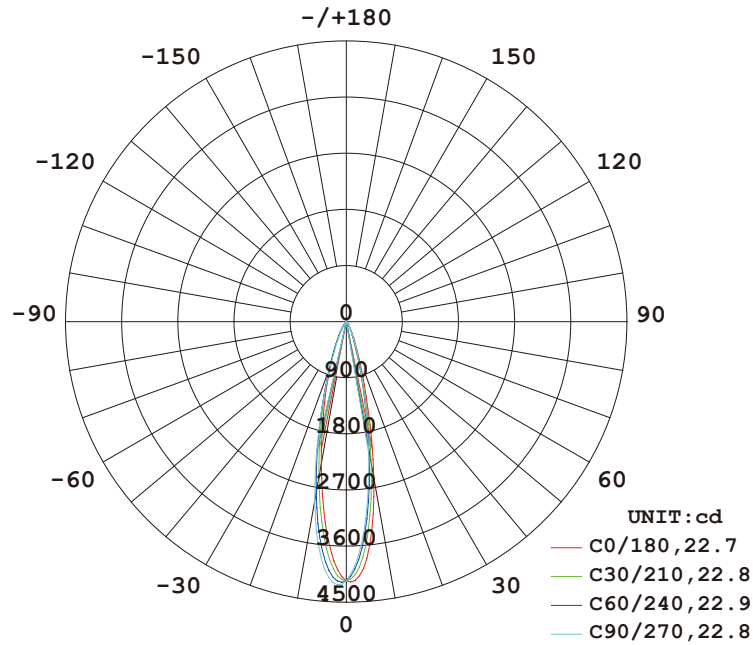

AVERAGE BEAM ANGLE (50%) : 22.8 DEG

Illuminance at a Distance

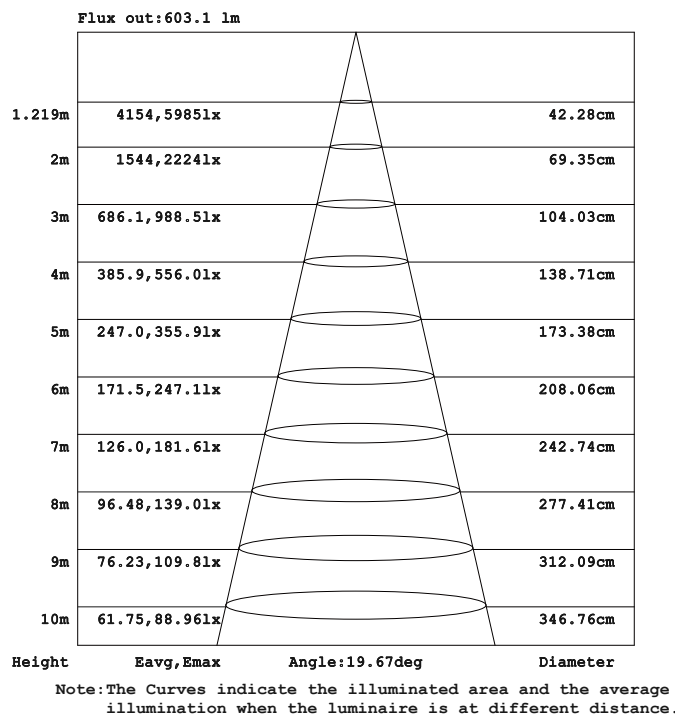

Model: NR-S35-ZD105-10 24°

LUMINOUS INTENSITY DISTRIBUTION DIAGRAM

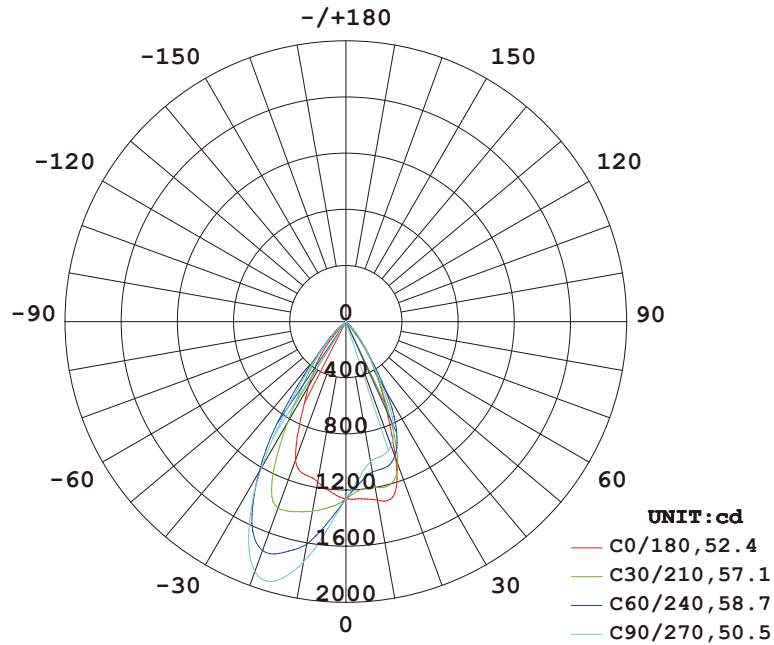

AVERAGE BEAM ANGLE (50%) : 54.7 DEG

Illuminance at a Distance

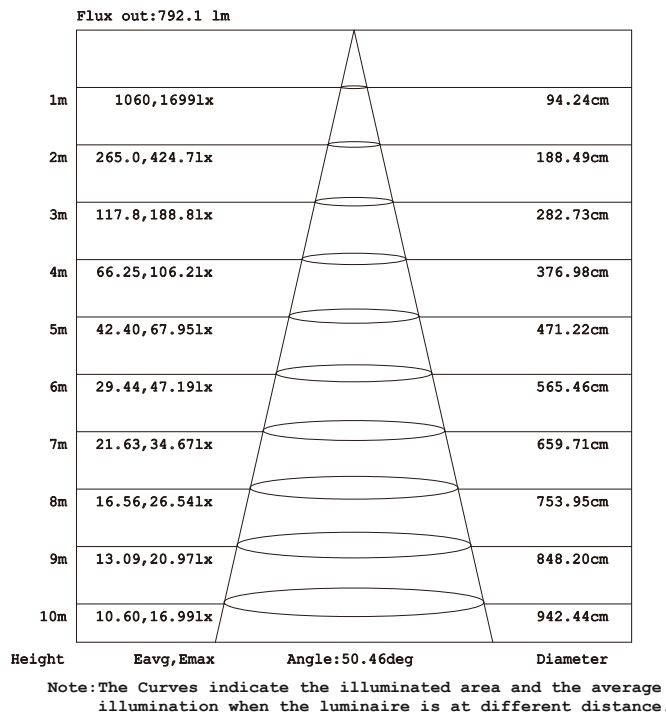

Model: NR-S35-ZD105-10 60°

LUMINOUS INTENSITY DISTRIBUTION DIAGRAM

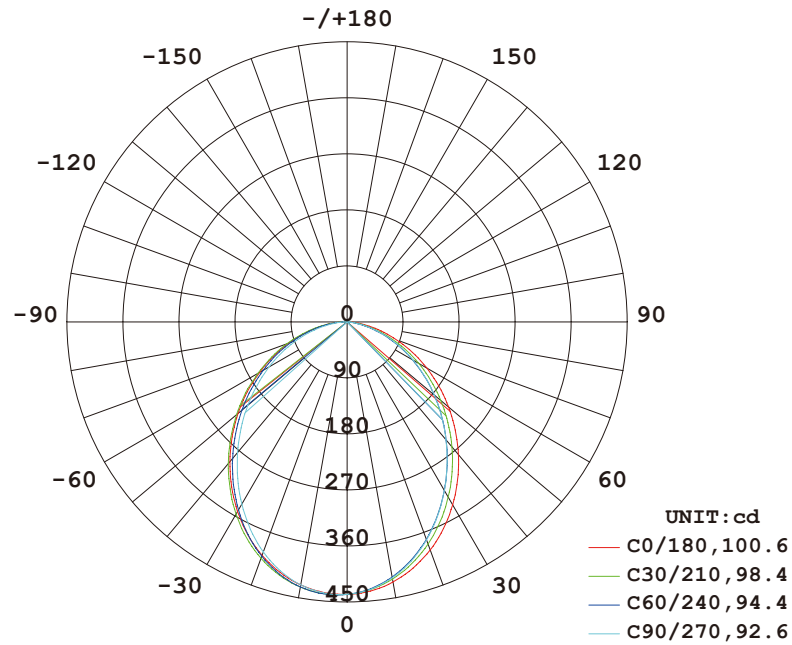

AVERAGE BEAM ANGLE (50%) : 96.5 DEG

Illuminance at a Distance

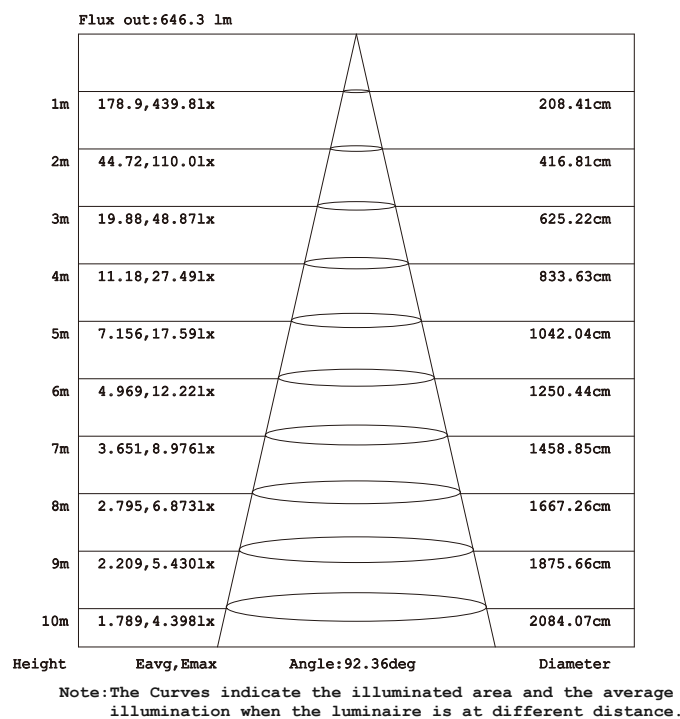

Model: NR-S35-ZP105-10 100°

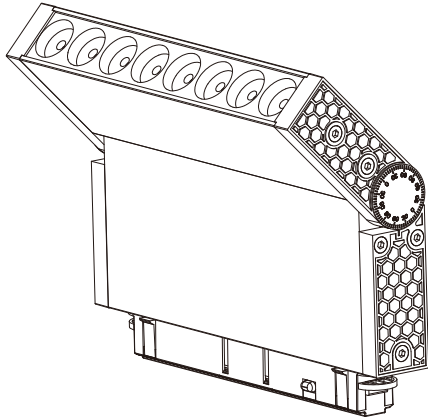

1

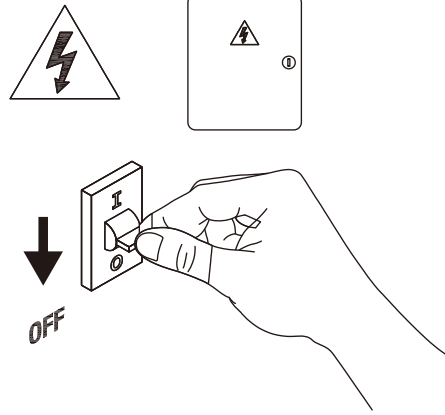

2

Turn off the power

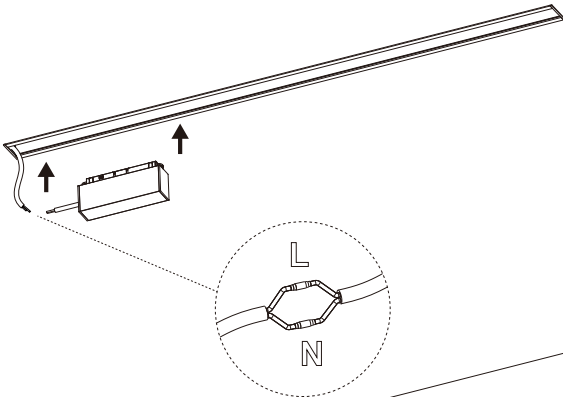

3

connect the cable

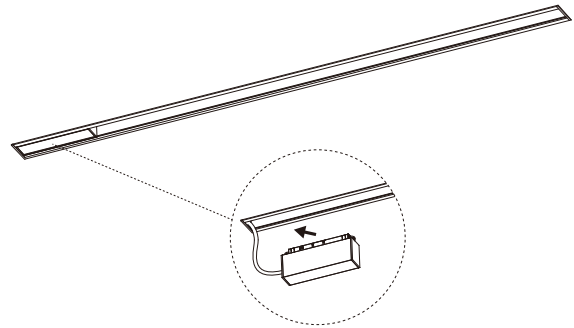

4

Install DC48V power supply

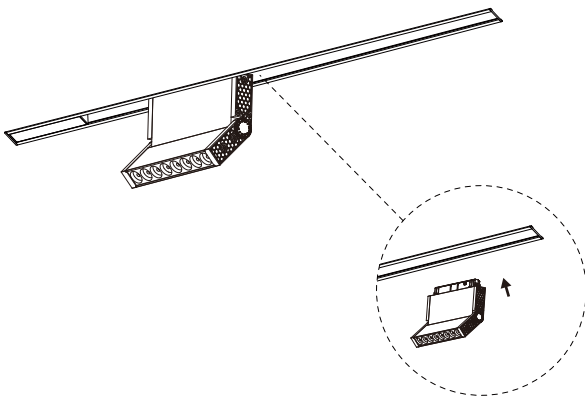

5

Install lamp the Installation is complete

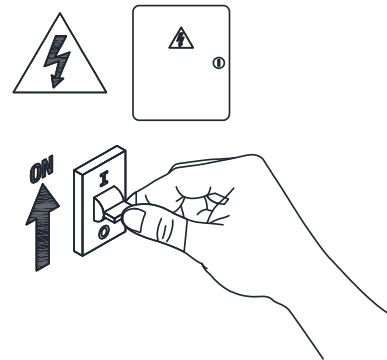

6

Turn on power

