

Aluminum Profile

PXG-1201H Series
IP20

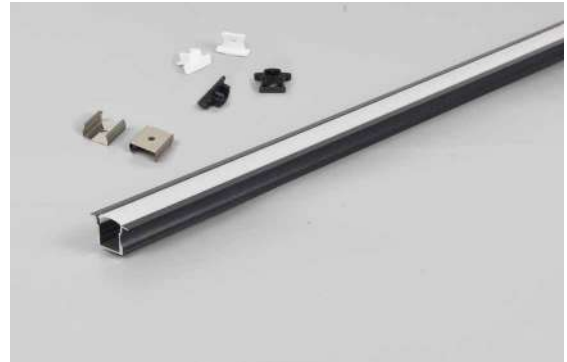

Item Code	Thickness (mm)	Frame Color	Material	Dimensions in mm					kg
				A	B	C	D	E	
PXG-1201H	1	Silver	Aluminum	4000	25	17	16	12	0.8
PXG-1201H-BK	1	Black	Aluminum	4000	25	17	16	12	0.8
PXG-1201H-PC	\	Milky white	PC	4000	5	16	\	\	0.06
PXG-1201H-BK-ACS	\	Silver	Aluminum	20	8.5	18	\	\	0.001
PXG-1201H-CAP	\	White	PC	25	13	15.5	\	\	0.001
PXG-1201H-BK-CAP	\	Black	PC	25	13	15.5	\	\	0.001

Dimensions in mm

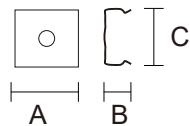

Item Code:PXG-1201H-BK-ACS

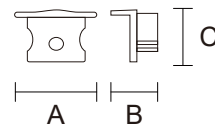

Item Code:PXG-1201H-BK-CAP

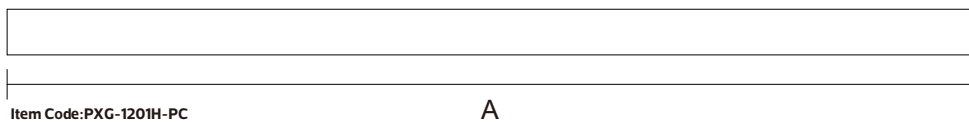

Item Code:PXG-1201H-PC

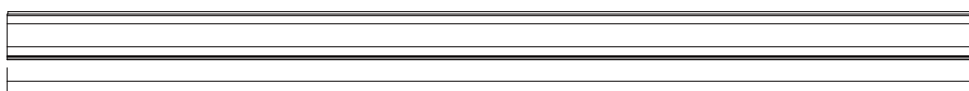

Item Code:PXG-1201H Series

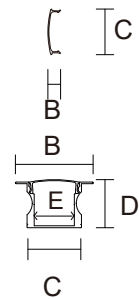

High Quality Aviation Aluminium Profiles

The profile is made of aviation aluminum, which is easy to process and has good wear resistance, corrosion resistance and oxidation resistance.

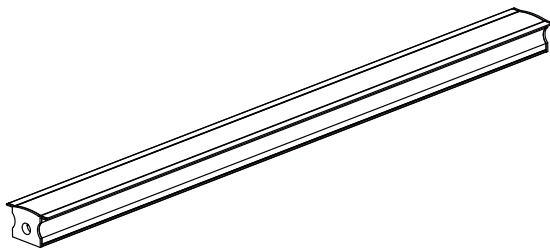

Description:
Aluminum Profile

Main material:
Engineering plastics+Aluminum

Specification
Simple and elegant, beautiful, with the use of lamp belt can make the whole room atmosphere upgrade grade IP20

Applications
•The Ground
•The Wall
•The ceiling

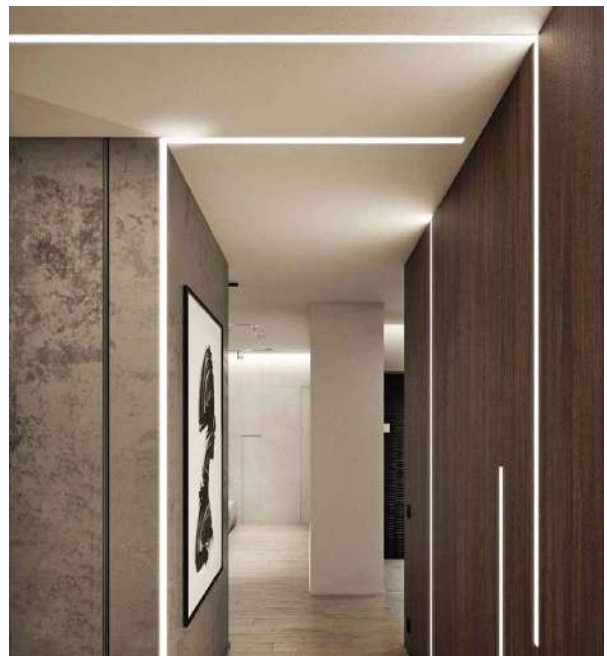
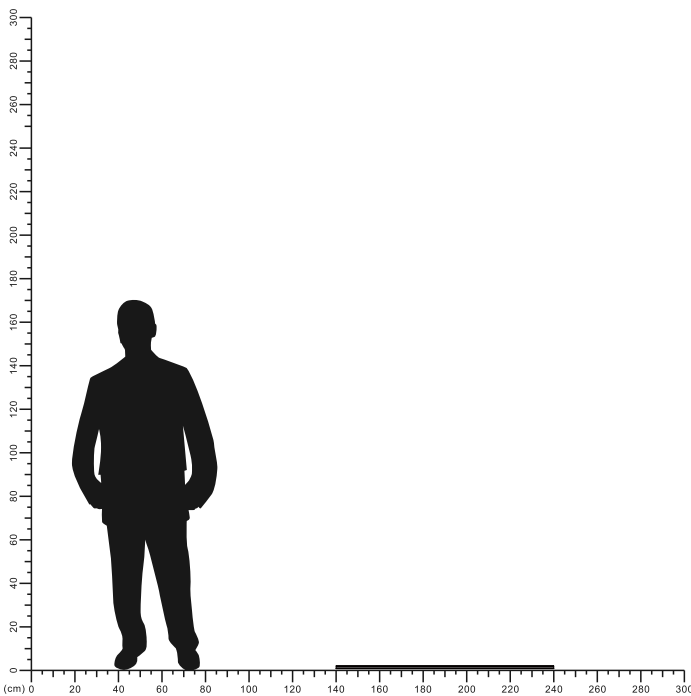



NOTE:

1. The installation of the product must be a professional electrician
2. The light source contained in this luminaire shall only be replaced by the manufacturer who is service agent or a similar qualified person.
3. Luminaire only suitable for indoor use.

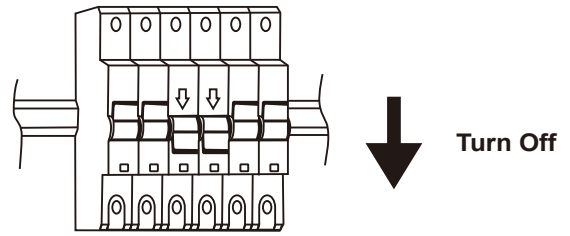

First, you make sure the power is off.

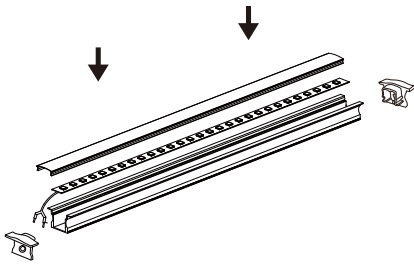

1

install the strip light into the aluminum profile, then put the cap install to the both side, finally install the PC cover.

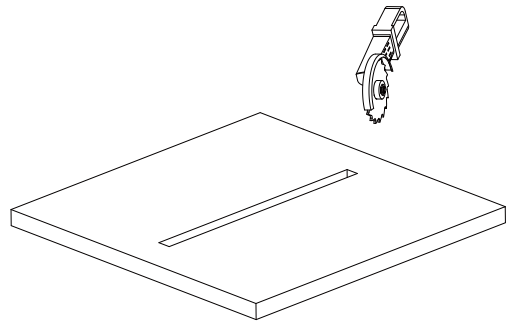

2

Grooves according to size

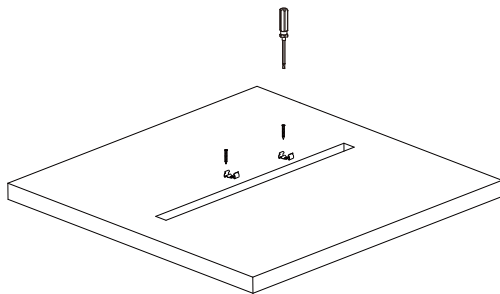

3

Install the buckle

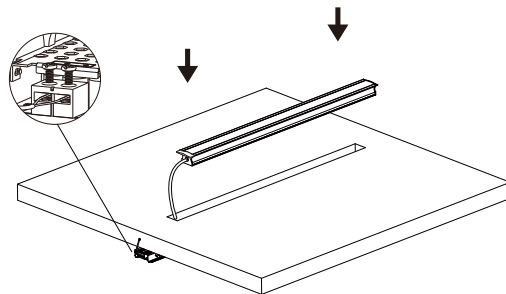

4

Connect the cable and Fix the light strip on the buckle

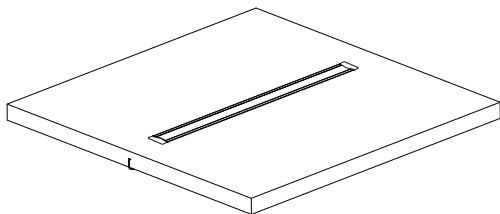

5

Installation completed

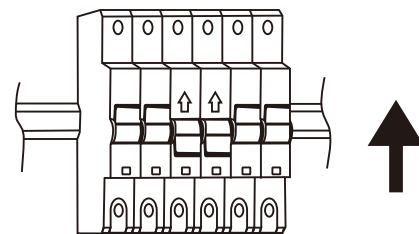

Turn On

