

Aluminum Profile

PXG-301
IP20



Item Code	Thickness (mm)	Frame Color	Material	Dimensions in mm				Strip Light Max Size (E mm)	kg
				A	B	C	D		
PXG-301	1.5	Silver	Aluminum	4000	32.4	12	13	10	0.88

Dimensions in mm

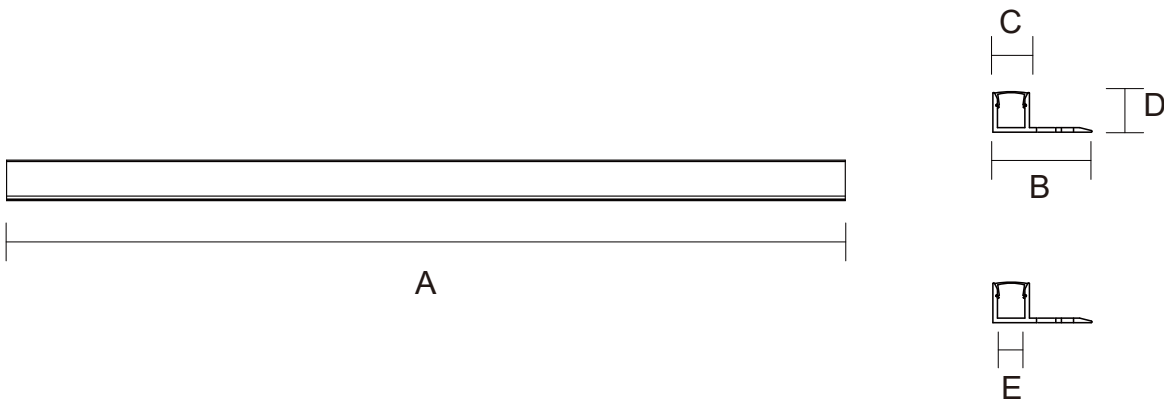

High Quality Aviation Aluminium Profiles

The profile is made of aviation aluminum, which is easy to process and has good wear resistance, corrosion resistance and oxidation resistance.

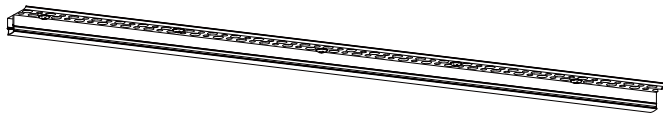

Description:
Aluminum Profile

Main material:
Engineering plastics+Aluminum

Specification
Simple and elegant, beautiful, with the use of lamp belt can make the whole room atmosphere upgrade grade IP20

Applications

- The Ground
- The Wall
- The ceiling

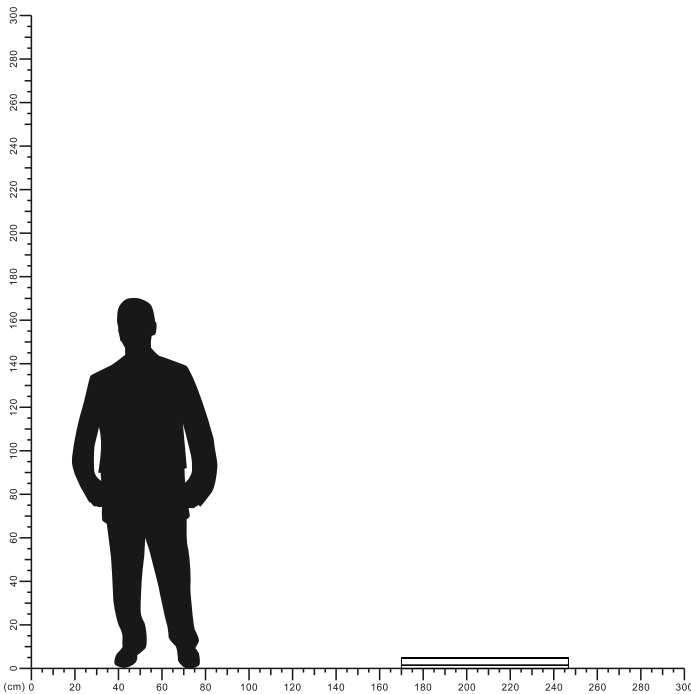



NOTE:

1. The installation of the product must be a professional electrician
2. The light source contained in this luminaire shall only be replaced by the manufacturer who is service agent or a similar qualified person.
3. Luminaire only suitable for indoor use.

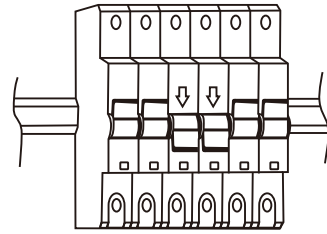

Turn Off

First, you make sure the power is off.

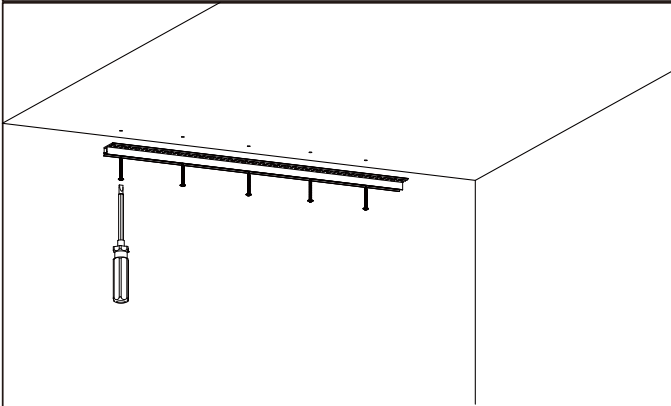

1

Install the strip light into the aluminum profile

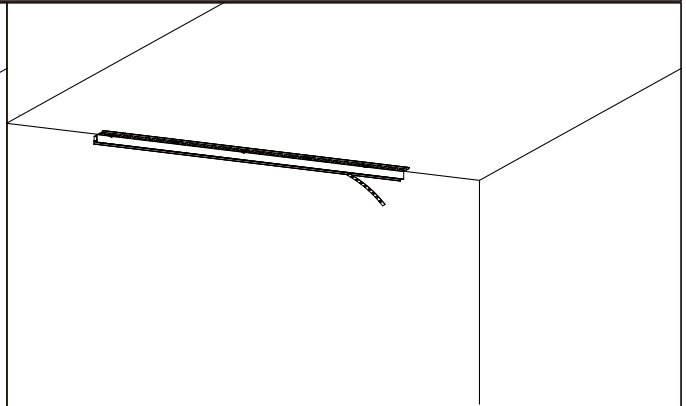

2

Mounting strip light

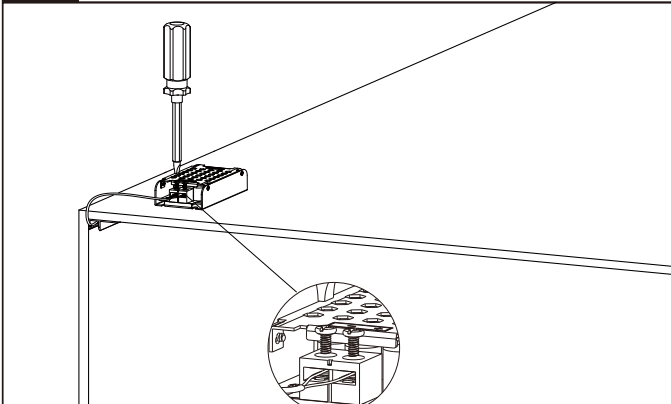

3

Connect the cable

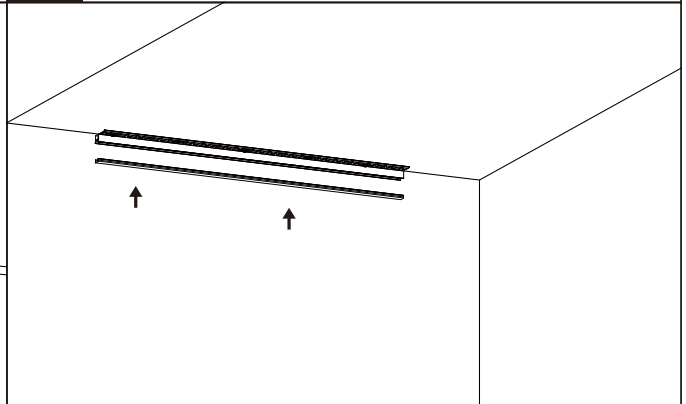

Install the PC cover

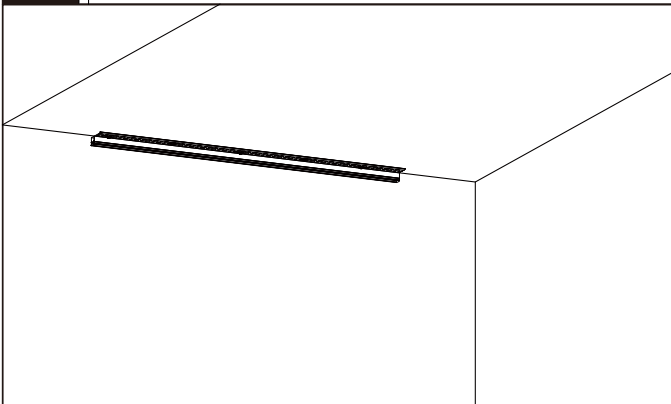

5

Installation completed

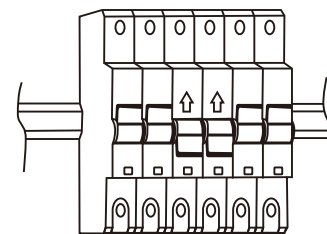

Turn on the power

