

Aluminum Profile

PXG-613C Series
IP20



Item Code	Thickness (mm)	Frame Color	Material	Dimensions in mm					kg
				A	B	C	D	E	
PXG-613C	1	Silver	Aluminum	4000	25	17	20	10	0.8
PXG-613C-BK	1	Black	Aluminum	4000	25	17	20	10	0.8
PXG-613C-PC	\	Milky white	PC	4000	5	16	\	\	0.06
PXG-613C-ACS	\	Silver	Aluminum+Iron	30.5	25	52			0.02
PXG-613C-CAP	\	White	PC	25	13	15.5	\	\	0.001
PXG-613C-CAP-BK	\	Black	PC	25	13	15.5	\	\	0.001

Dimensions in mm

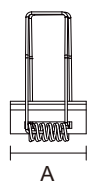

Item Code: PXG-613C-ACS

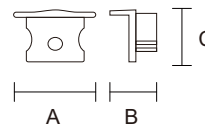
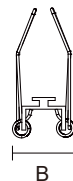

Item Code: PXG-613C-CAP Series

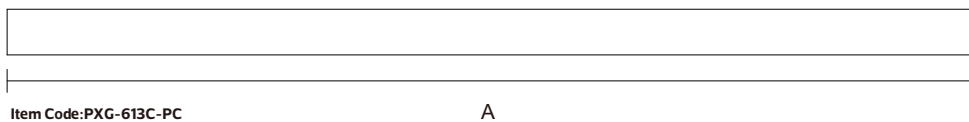

Item Code: PXG-613C-PC

A

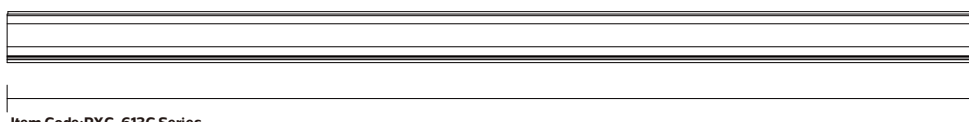

Item Code: PXG-613C Series

A

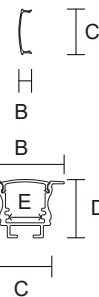

High Quality Aviation Aluminium Profiles

The profile is made of aviation aluminum, which is easy to process and has good wear resistance, corrosion resistance and oxidation resistance.

PC Cover

Aluminum

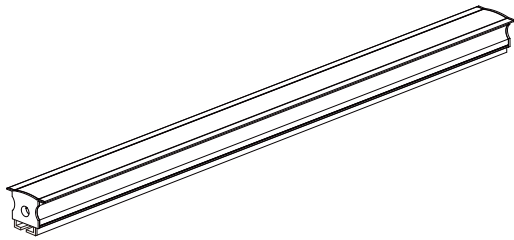

Description:
Aluminum Profile

Main material:
Engineering plastics+Aluminum

Specification
Simple and elegant, beautiful, with the use of lamp belt can make the whole room atmosphere upgrade grade IP20

Applications

- The Ground
- The Wall
- The ceiling

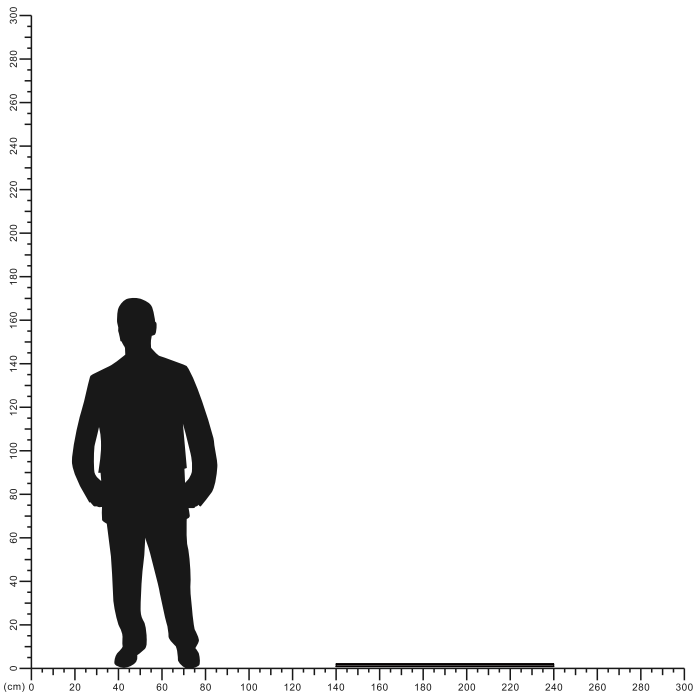



NOTE:

1. The installation of the product must be a professional electrician
2. The light source contained in this luminaire shall only be replaced by the manufacturer who is service agent or a similar qualified person.
3. Luminaire only suitable for indoor use.

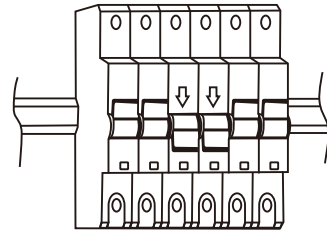

Turn Off

First, you make sure the power is off.

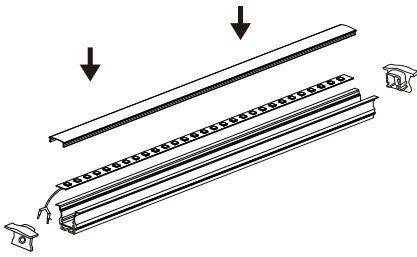

1

install the strip light into the aluminum profile, then put the cap install to the both side, finally install the PC cover.

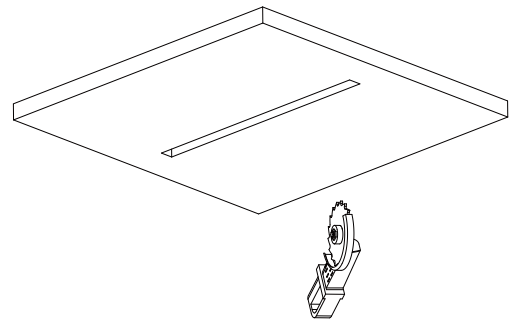

2

Grooves according to size

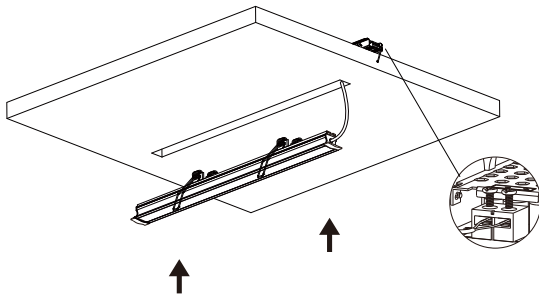

3

Connect the cable

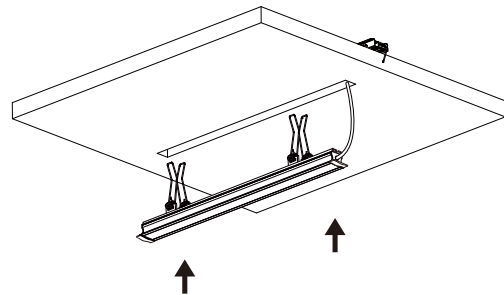

4

Release the spring and fix it in the groove

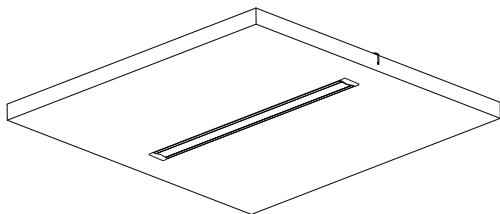

5

Installation completed

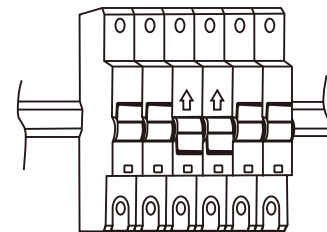

Turn On

