

## Aluminum Profile

PXG-618 Series  
IP20



Item Code	Thickness (mm)	Frame Color	Material	Dimensions in mm					kg
				A	B	C	D	E	
PXG-618	1	Silver	Aluminum	4000	21	7	12	16	0.30
PXG-618-BK	1	Black	Aluminum	4000	21	7	12	16	0.30
PXG-618-ACS	0.2	Silver	Stainless steel	10	17	7	\	\	0.01
PXG-618-CAP	\	White	PC	20	22	6	\	\	0.01
PXG-618-CAP-BK	\	Black	PC	20	22	6	\	\	0.01
PXG-618-PC	1	White	PC	4000	7	4	\	\	0.05

### Dimensions in mm

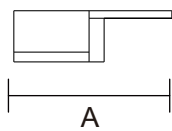

Item Code:PXG-618-CAP

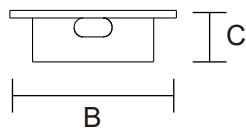

Item Code:PXG-618-ACS

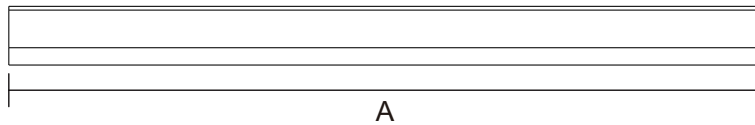
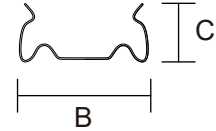

Item Code:PXG-618

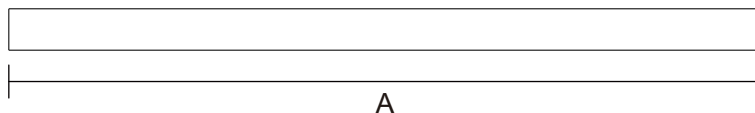
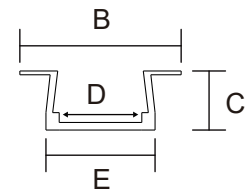

Item Code:PXG-618-PC

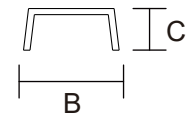

**High Quality Aviation Aluminium Profiles**

The profile is made of aviation aluminum, which is easy to process and has good wear resistance, corrosion resistance and oxidation resistance.

PC Cover

AlumInlum

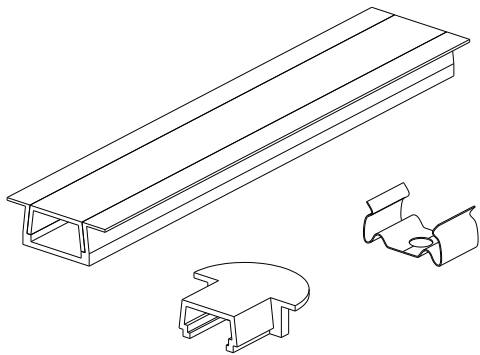
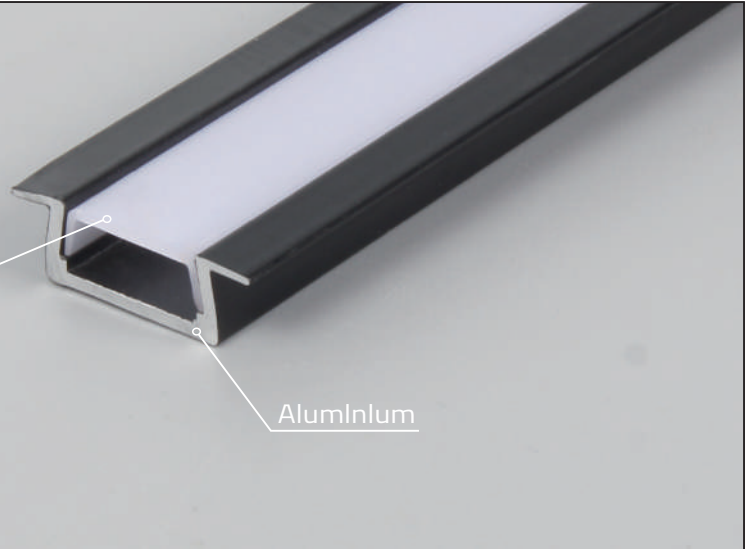

**Description:**  
Aluminum Profile

**Main material:**  
Engineering plastics+Aluminum

**Specification**  
Simple and elegant, beautiful, with the use of lamp belt can make the whole room atmosphere upgrade grade IP20

**Applications**  
•The Ground  
•The Wall  
•The ceiling

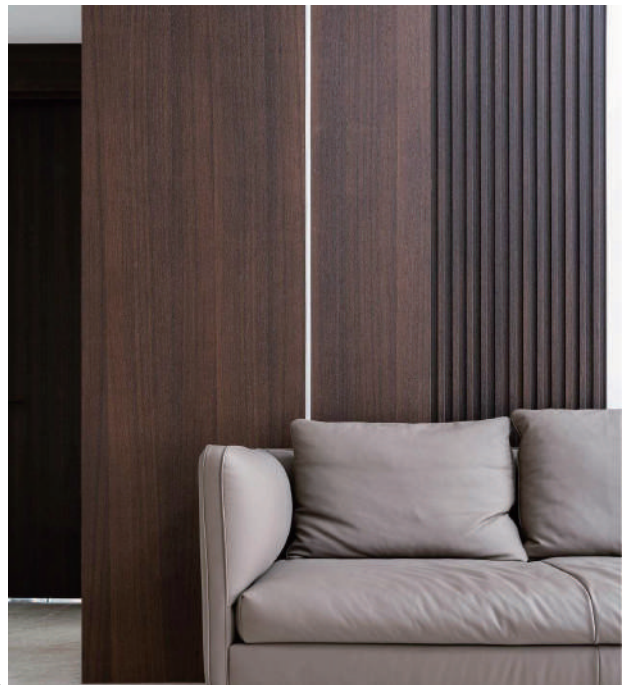
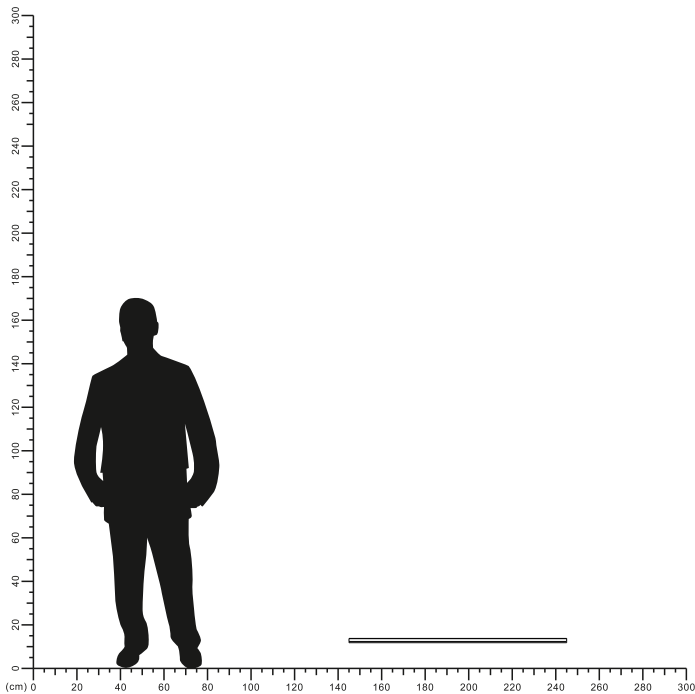



**NOTE:**

1. The installation of the product must be a professional electrician
2. The light source contained in this luminaire shall only be replaced by the manufacturer who is service agent or a similar qualified person.
3. Luminaire only suitable for indoor use.

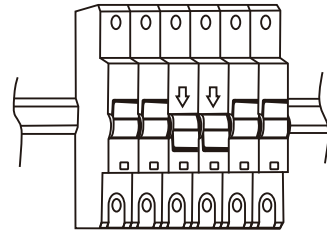

Turn Off

First, you make sure the power is off.

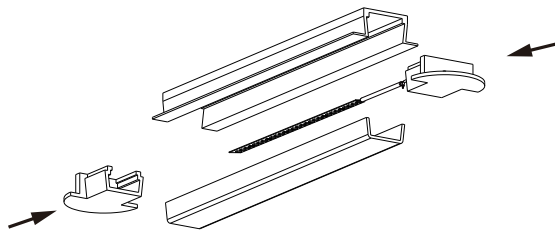

**1**

install the strip light into the aluminum profile, then put the cap install to the both side, finally install the PC cover.

**2**

Grooves according to size

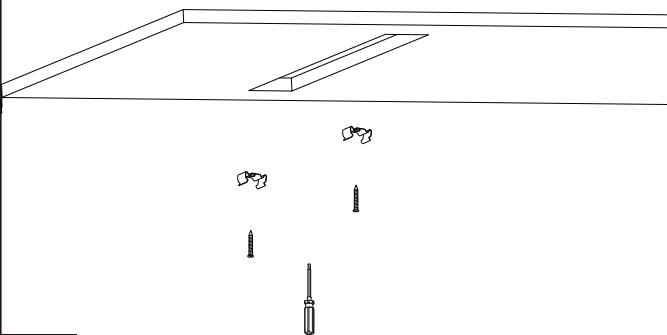
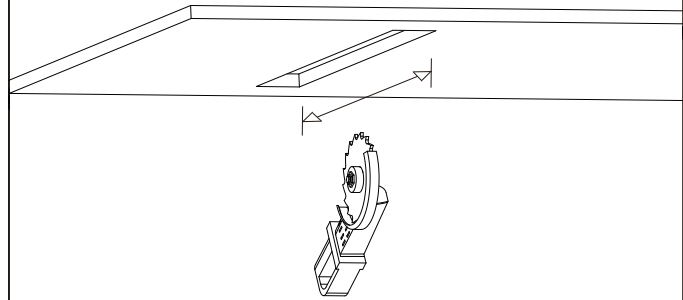

**3**

Install aluminum clasps

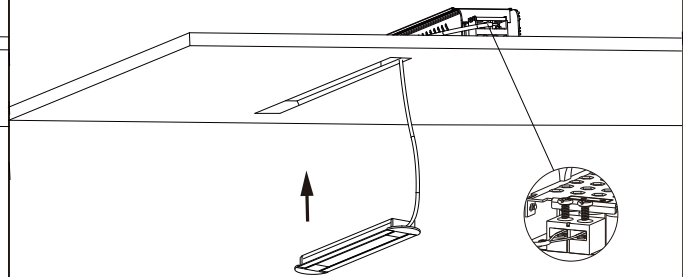

**4**

Connect the cable and snap the aluminum into the clasp

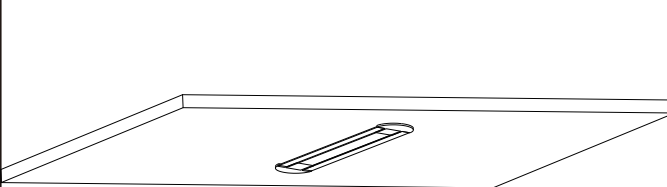

**5**

Installation completed

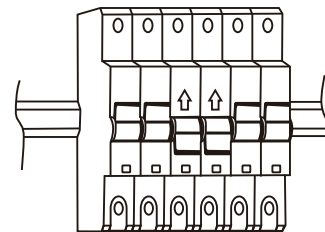

Turn On

