

Lamp Accessories

W2-1007B

IP65



| Item Code | Socket | Dimensions in mm | | | kg |
|-----------|-------------------------|------------------|-----|-----|-----|
| | | A | B | C | |
| W2-1007B | E27*1(Max Size: Φ135mm) | 181 | 197 | 615 | 2.5 |

Dimensions in mm

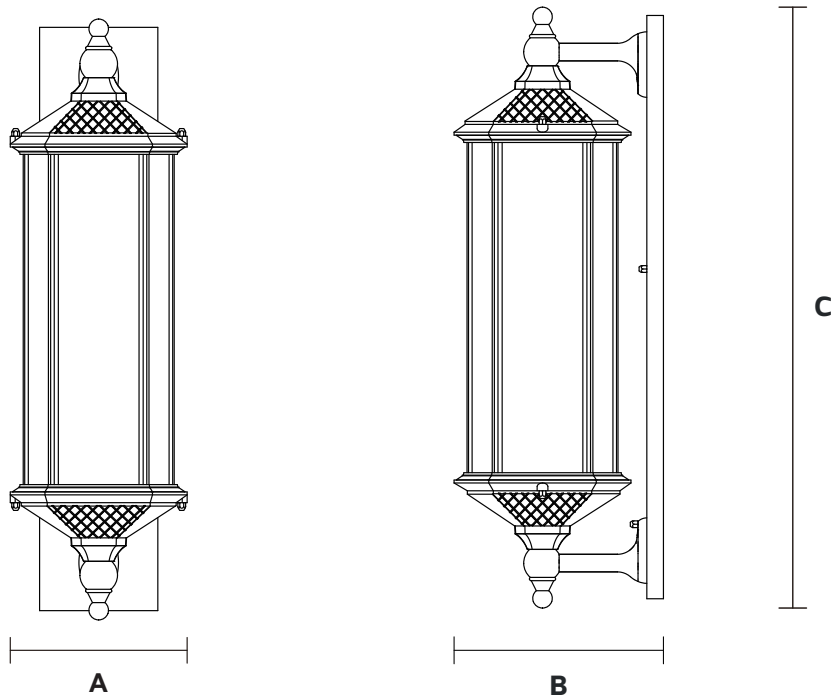

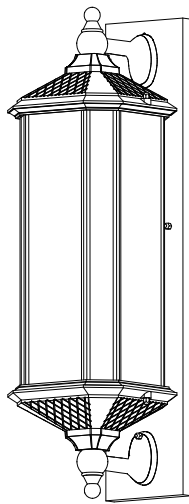

Description:
Lamp Accessories

Main material:
Die-cast aluminum+ Transparent engraved glass

Specification
Durable lamp body, integrated die-casting forming, with a hard texture but wear resistance.
High transparency glass, High transmittance of 98%.

IP 65

- Applications**
- . Living room
 - . Courtyard
 - . Street
 - . Restaurant

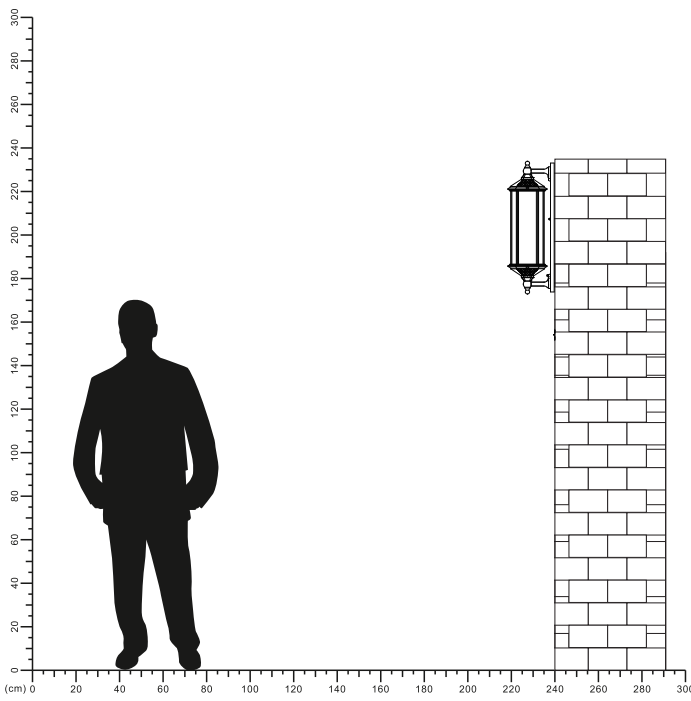

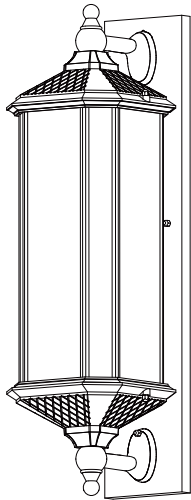

- ⌈ X 20
- X 17
- ⌈ X 7
- ⌈ X 6
- ⌈ X 3
- ⌈ X 3
- ⌈ X 2

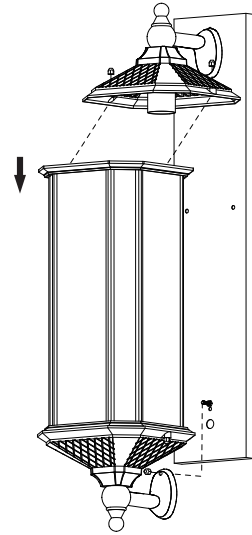

1

Remove the lampshade

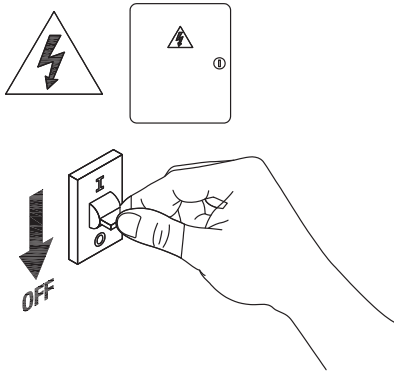

2

Turn off the power

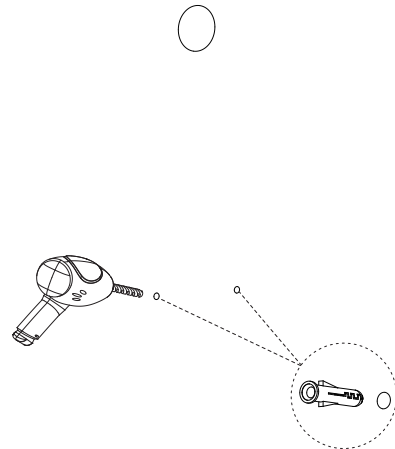

3

Drill holes in the wall insert expansion screws

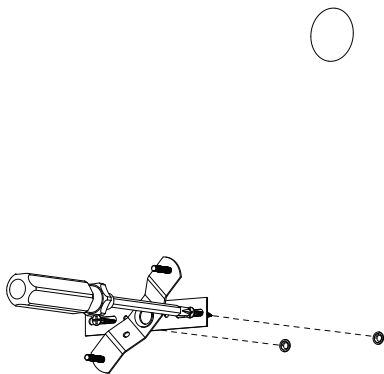

4

To install the hanging board

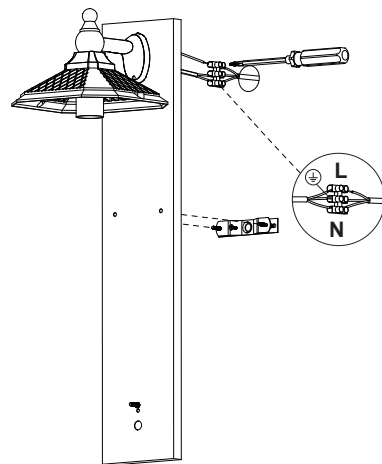

5

Connecting the power cord

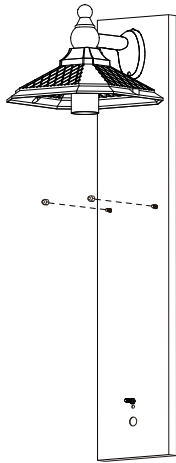

6

Fix the lamp holder properly

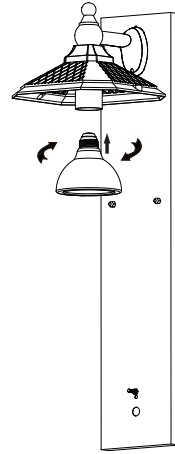

7

Tighten the bulb

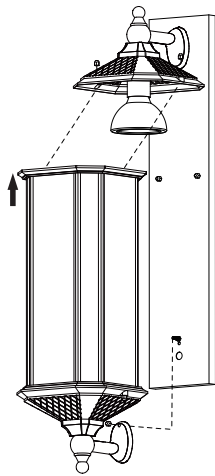

8

Install the lampshade

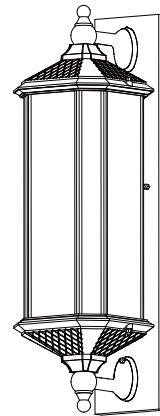

9

Installation is complete

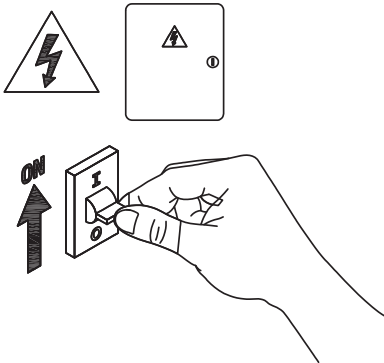

10

Turn on the power

Installation completed

Installation completed

Fixed to the wall installation completed

