

LED OUTDOOR WALL LAMP

W2812

IP65



Outdoor 	AC 220-240V	50/60 Hz	PF ≥0.7	CCT 3000K	Ra ≥80	IP65	Beam Angel 150°	Chips SMD	
--------------------	-----------------------	--------------------	-------------------	---------------------	------------------	-------------	---------------------------	----------------------------	--

Item Code	P (W)	CCT(K)	Beam angle	Output (lm)	lm/w	Dimensions in mm			
						A	B	C	
W2812	12	3000	150°	900	75	180	110	110	0.69

Dimensions in mm

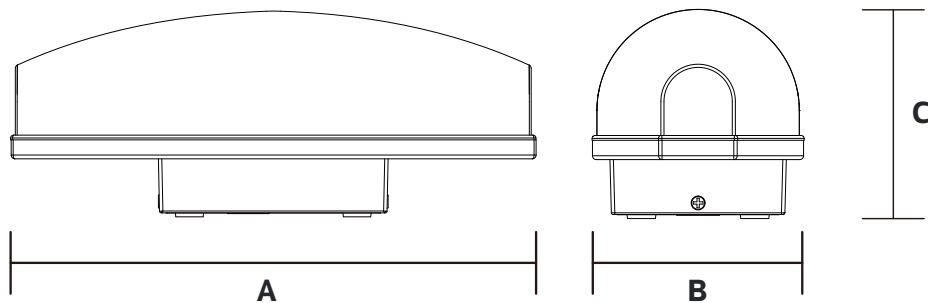

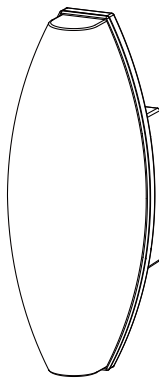

Description:
LED OUTDOOR WALL LAMP



Main material:
Aluminum+Engineering plastics

Specification
Energy saving, up to 85% energy saving comparing to standard halogen and incandescent lamps
High quality light, high color rendering, less heat, no UV or IR radiation
Build-in LED Driver
IP65

Applications

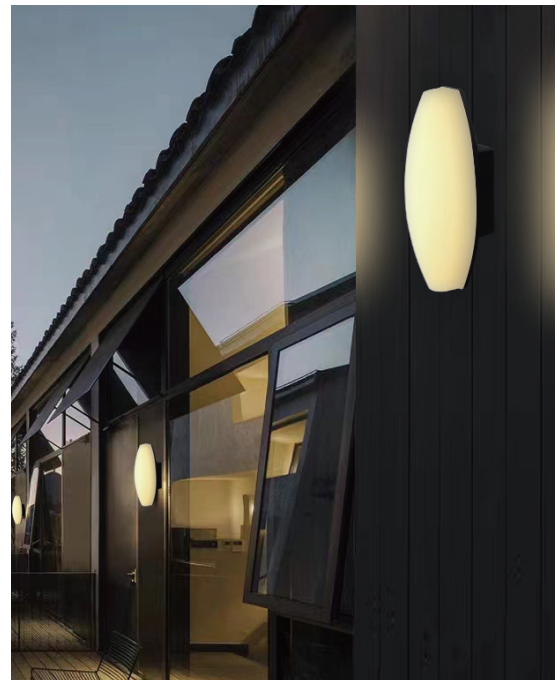
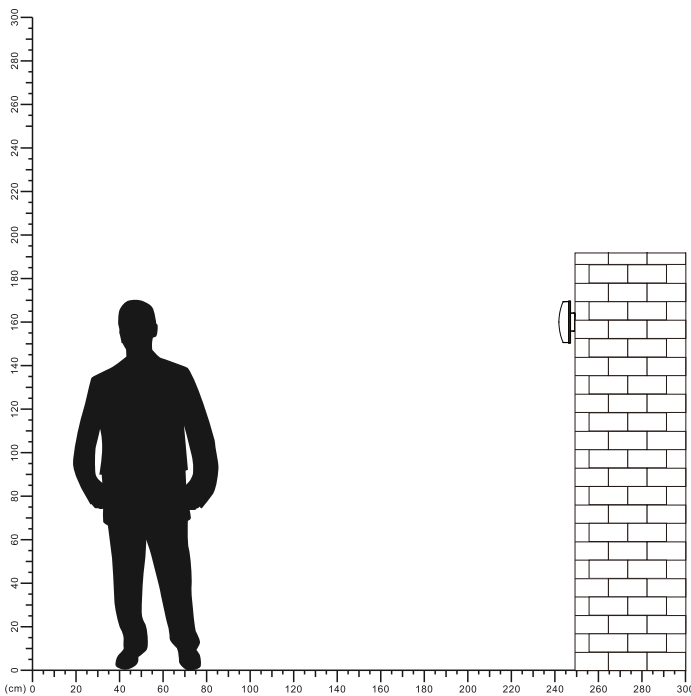
- . Park
- . Square
- . Tourist attraction
- . Corridor

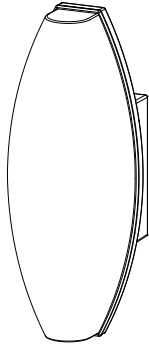
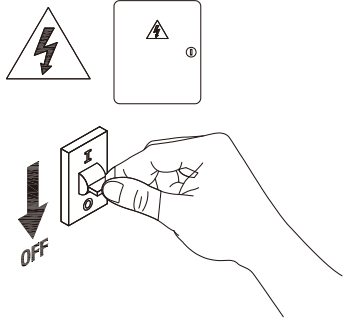
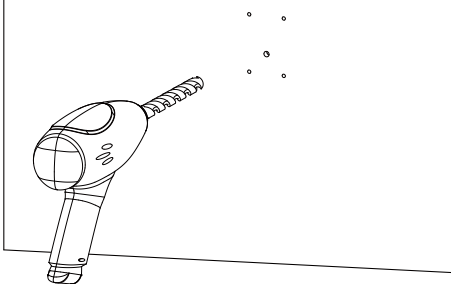
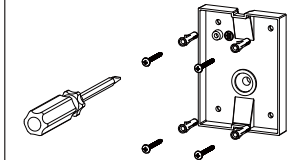
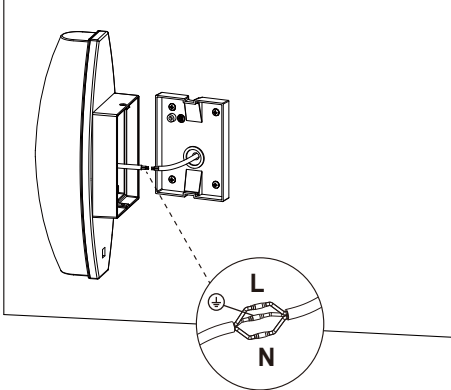
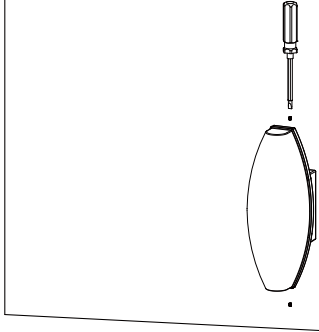

<p>1</p> 	<p>2</p> <p>Turn off the power</p> 
<p>3</p> <p>Drill 5 holes on your wall</p> 	<p>4</p> <p>Install the screw</p> 
<p>5</p> <p>Connect the cable</p> 	<p>6</p> <p>Fixing the lamp body</p> 
<p>7</p> <p>Installation completed</p> 	<p>8</p> <p>Turn on power</p> 