

Lamp Accessories

WD-1044

IP65



Item Code	Socket	Dimensions in mm			kg
		A	B	C	
WD-1044	E27*1(Max Size: Φ90mm)	164	230	400	1.9

Dimensions in mm

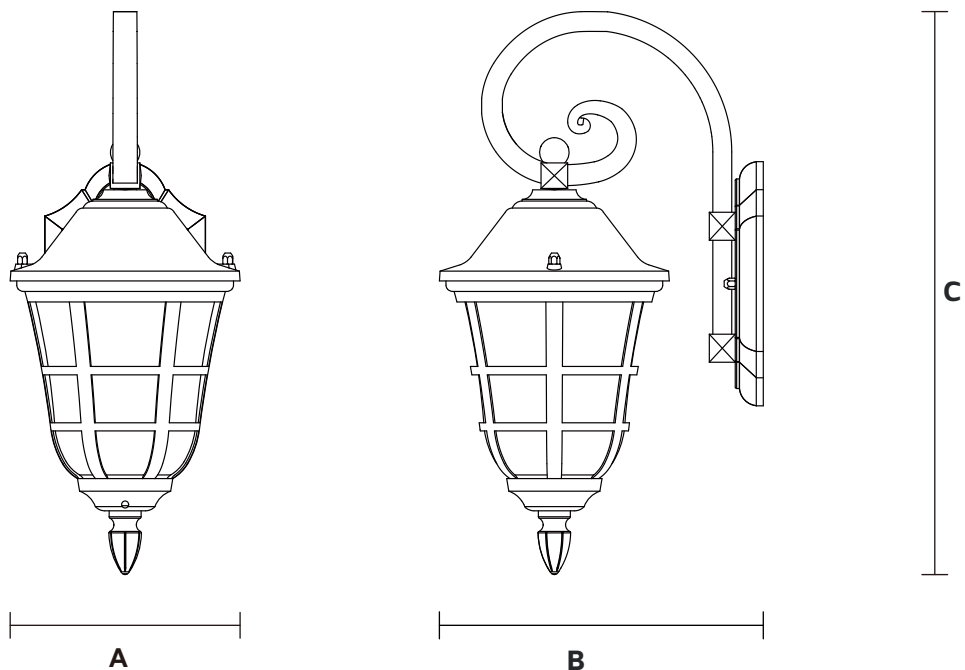

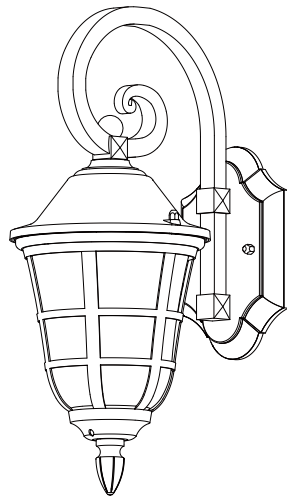

Description:
Lamp Accessories

Main material:
Die-cast aluminum+ Transparent glass

Specification
Durable lamp body, integrated die-casting forming, with a hard texture but wear resistance.
High transparency glass, soft and not dazzling light.

IP 65

Applications

- . Villas
- . Parks
- . Communities

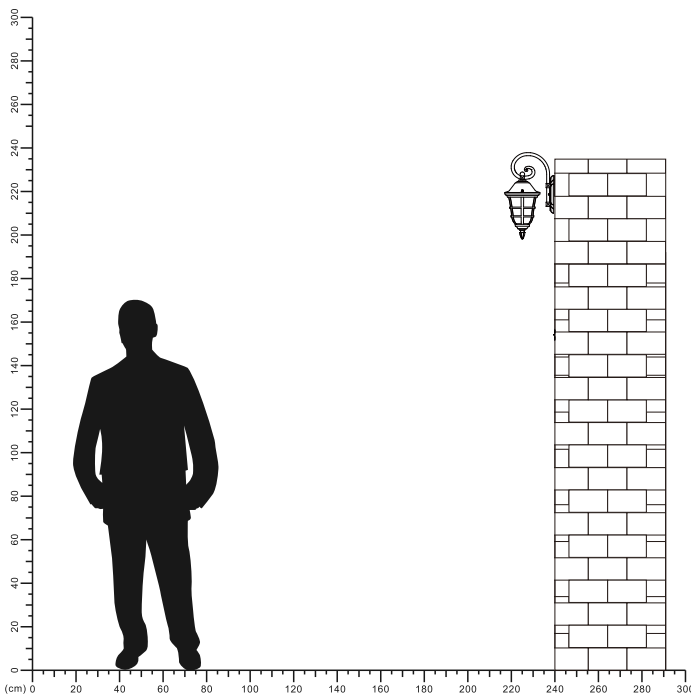

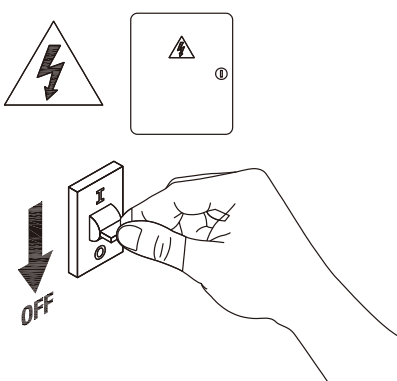
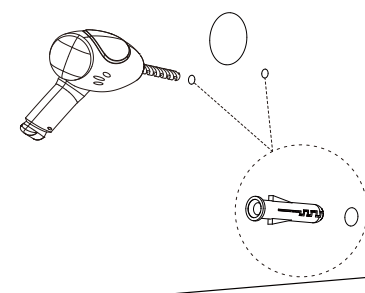
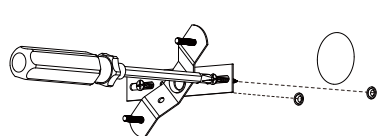
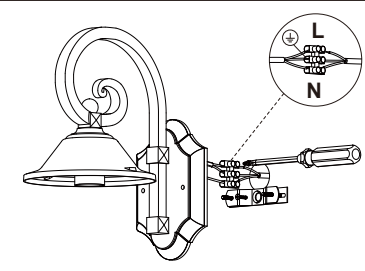
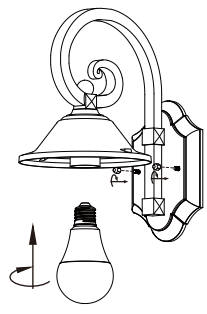
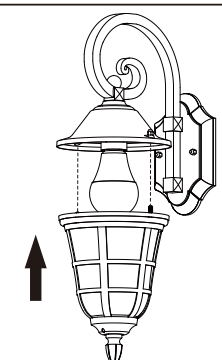
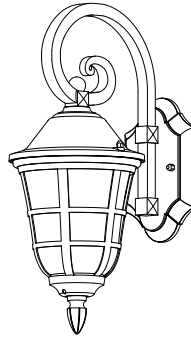
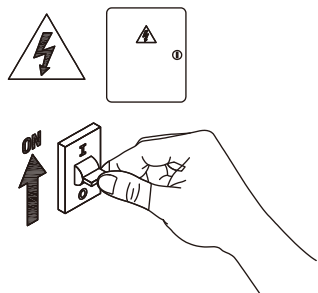
 <p>1 Turn off the power</p>	 <p>2 Drill holes in the wall insert expansion screws</p>
 <p>3 To install the hanging board</p>	 <p>4 Connecting the power cord</p>
 <p>5 Fix the lamp holder and tighten the bulb</p>	 <p>6 Align the screw cap fixed lampshade</p>
 <p>7 Installation completed</p>	 <p>8 Turn on the power</p>

