

LED Wall Lamp

WL-163041

IP20



Item Code	Cap Type	Dimensions in mm			kg
		A	B	C	
WL-163041	E14*2	300	200	780	1.2

Dimensions in mm

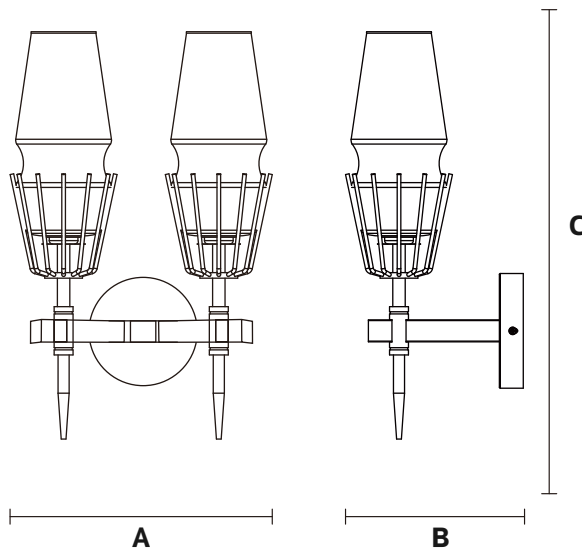

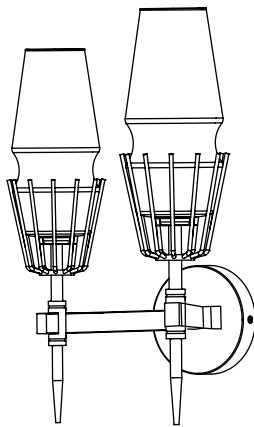

Description:
LED Wall Lamp

Main material:
Iron + glass

Specification

Special tree branch shape appearance, simple but full of personality and creative, randomly match the scene.
IP20

Applications

- . Hotel
- . Drawing room
- . Corridor

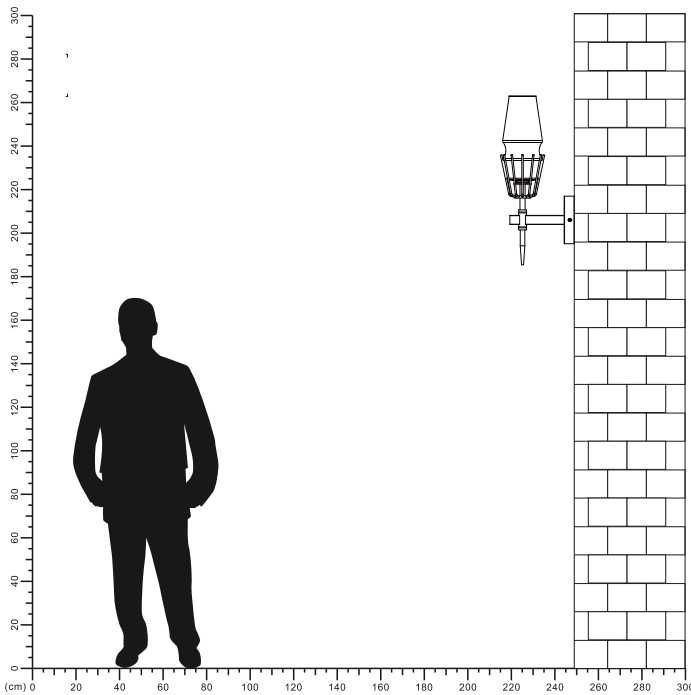

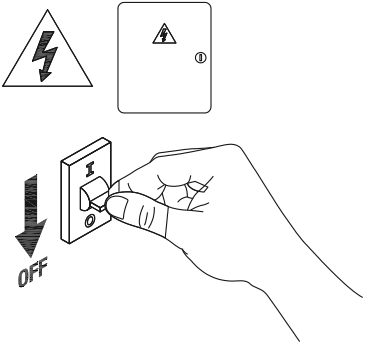
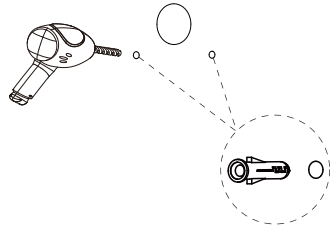
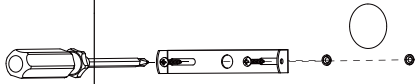
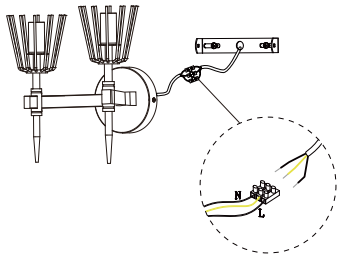
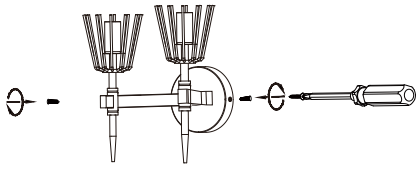
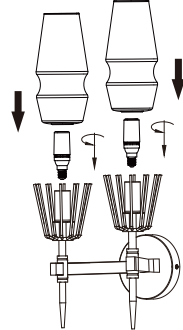
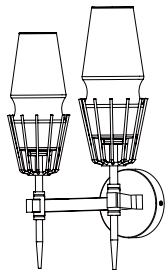
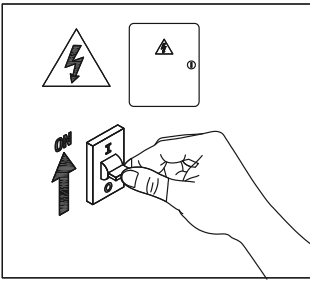
 <p>1 Turn off The Power</p>	 <p>2 Drill holes in the wall insert expansion screws</p>
 <p>3 Install base plate</p>	 <p>4 Connect the cable</p>
 <p>5 Secure the lamp body</p>	 <p>6 Tighten the bulb and insert the lampshade</p>
 <p>7 Installation completed</p>	 <p>8 Turn on the power</p>

