

Lamp Accessories

WL-6014 Series

IP20



| Item Code | Socket | Color | kg |
|------------|----------------------|-------|------|
| WL-6014-BK | E14*1(Max Size:55mm) | Black | 1.22 |
| WL-6014-G | E14*1(Max Size:55mm) | Gold | 1.22 |

Dimensions in mm

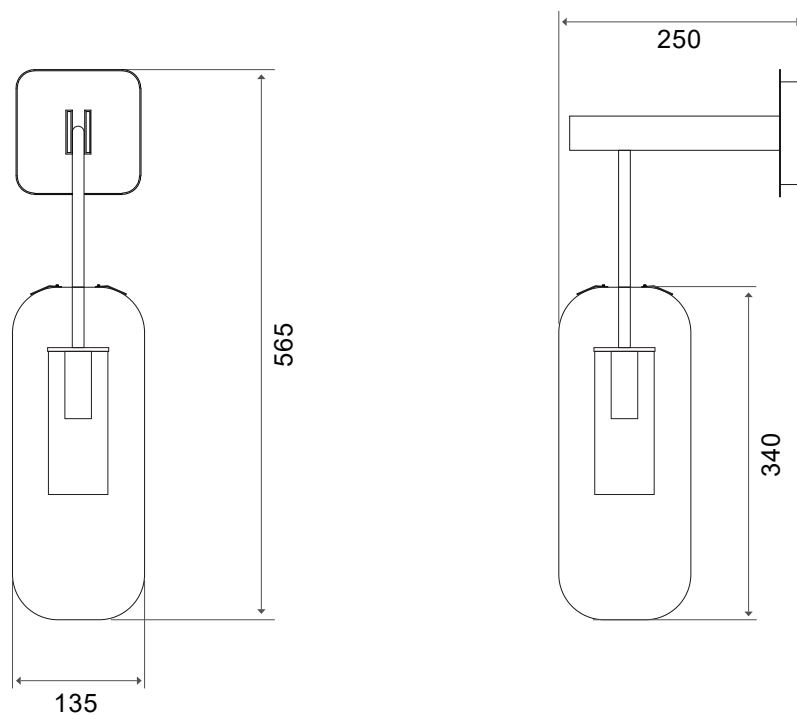

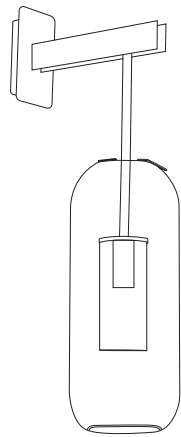

Description:

Lamp Accessories

Main material:

Die-cast aluminum+ glass

Specification

Stable lamp body under stress, Die cast aluminum molding, antioxidant, High transmittance of 98%, beautiful and practical, detachable IP 20

Applications

- . Villas
- . Parks
- . Communities

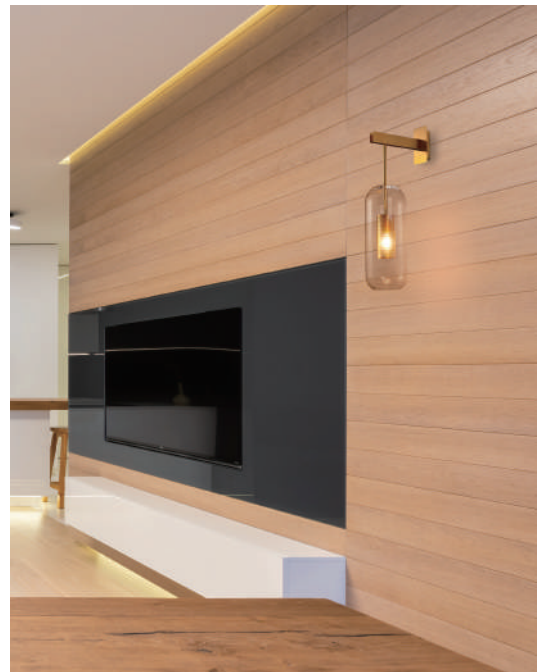
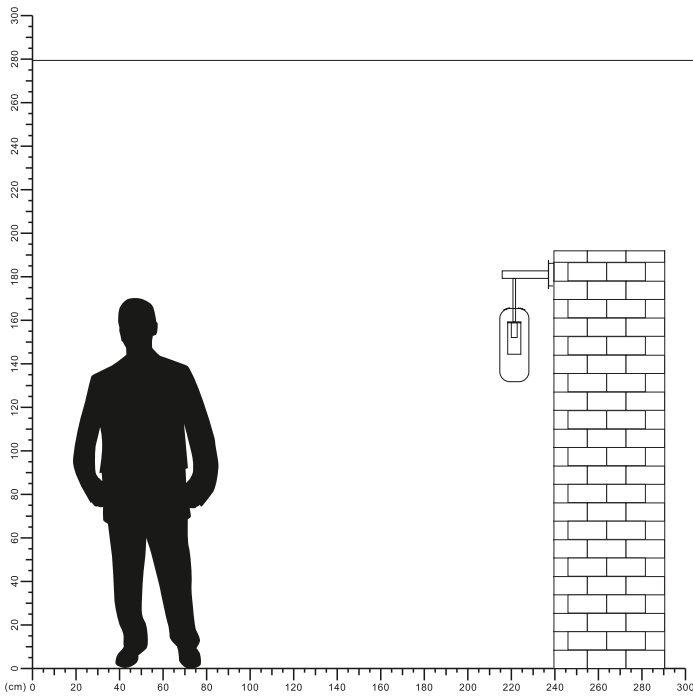

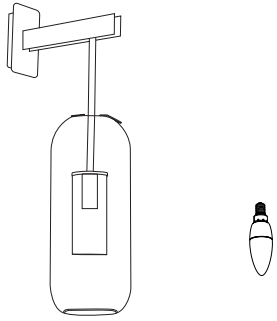

1

Turn off the power

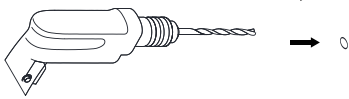
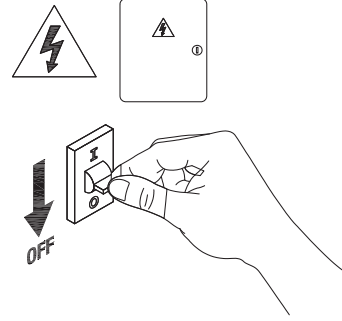

2

Drill two screw holes on the wall

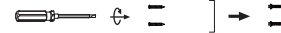

3

Install the base plate

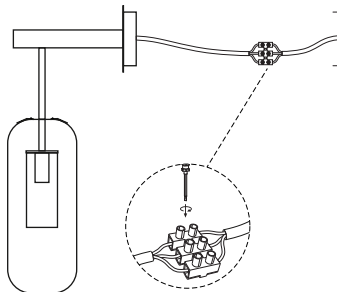

4

Connect Cable

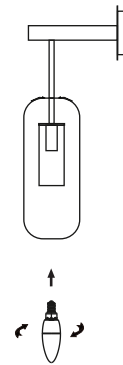

5

Install E14 bulb

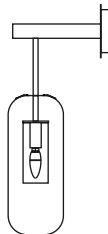

6

Installation completed

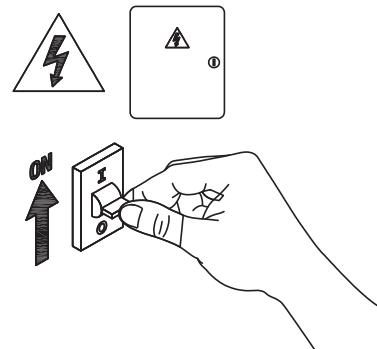

7

Turn on power

