

Aluminum Profile

XT-280 Series
IP20



Item Code	Thickness (mm)	Frame Color	Material	Dimensions in mm				kg
				A	B	C	D	
XT-280	1	Silver	Aluminum	4000	18	6	10.5	0.25
XT-280-BK	1	Black	Aluminum	4000	18	6	10.5	0.25
XT-280-PC	\	Milky white	PC	4000	4	9	\	0.06
XT-280-ACS	\	Silver	Stainless steel	20	8	18	\	0.001
XT-280-CAP	\	White	PC	17	5.5	6.5	\	0.001
XT-280-CAP-BK	\	Black	PC	17	5.5	6.5	\	0.001

Dimensions in mm

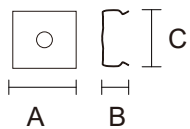

Item Code: XT-280-BK-ACS

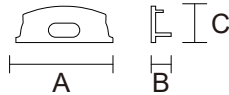

Item Code: XT-280-CAP Series

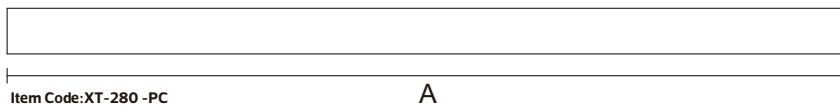

Item Code: XT-280-PC

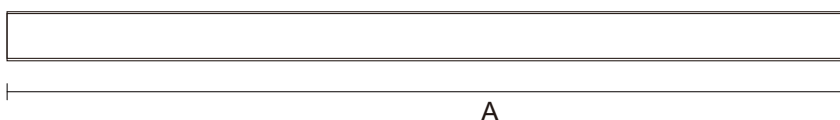

Item Code: XT-280 Series

High Quality Aviation Aluminium Profiles

The profile is made of aviation aluminum, which is easy to process and has good wear resistance, corrosion resistance and oxidation resistance.

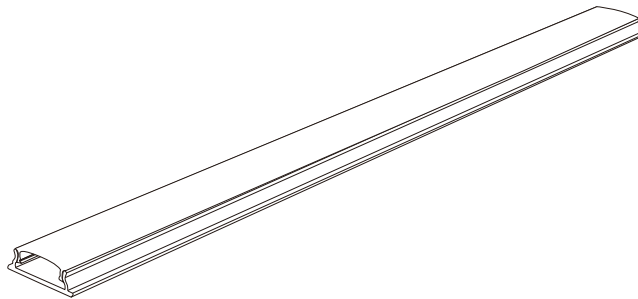

Description:
Aluminum Profile

Main material:
Engineering plastics+Aluminum

Specification
Simple and elegant, beautiful, with the use of lamp belt can make the whole room atmosphere upgrade grade IP20

Applications
•The Ground
•The Wall
•The ceiling

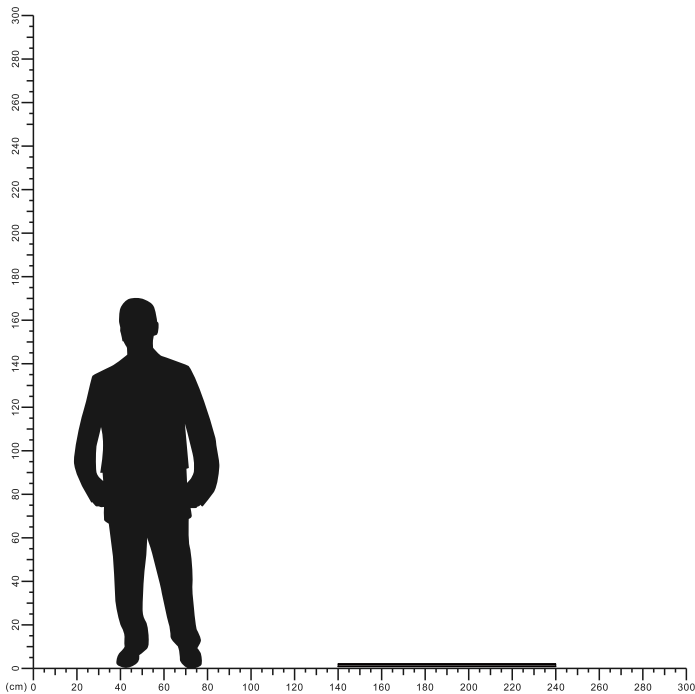



NOTE:

1. The installation of the product must be a professional electrician
2. The light source contained in this luminaire shall only be replaced by the manufacturer who is service agent or a similar qualified person.
3. Luminaire only suitable for indoor use.

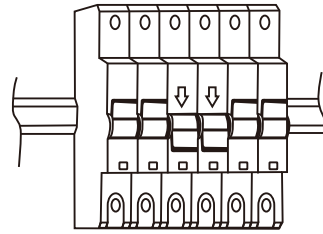

Turn Off

First, you make sure the power is off.

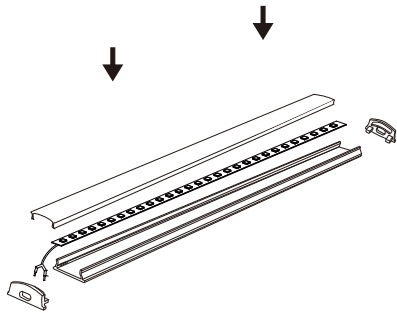

1

install the strip light into the aluminum profile, then put the cap install to the both side, finally install the PC cover.

2

Install the buckle

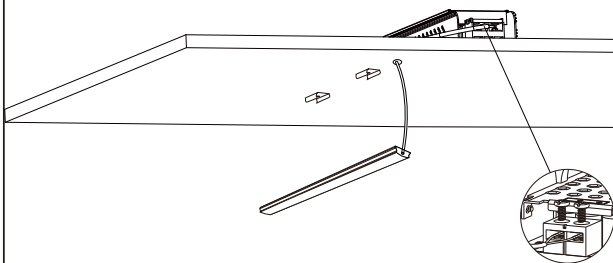

3

Connect the cable

4

Fix the light strip on the buckle

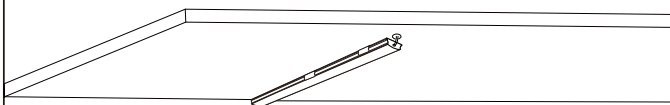
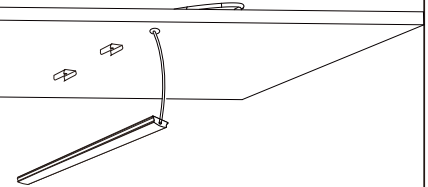

5

Installation completed

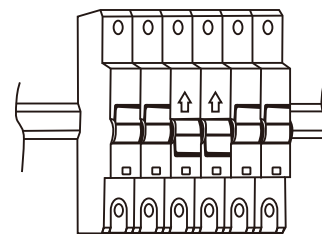

Turn On

