

Lamp Accessories

YD-2038-300

IP20



Item Code	Cap Type	Color	Dimensions in mm				kg
			A	B	C	D	
YD-2038-200	E27*1(Max Size Φ 85mm)	Copper	175	1478	Φ 200	Φ 100	1.63
YD-2038-250	E27*1(Max Size Φ 90mm)	Copper	225	1478	Φ 250	Φ 100	1.65
YD-2038-300	E27*1(Max Size Φ 95mm)	Copper	275	1478	Φ 300	Φ 100	1.67

Dimensions in mm

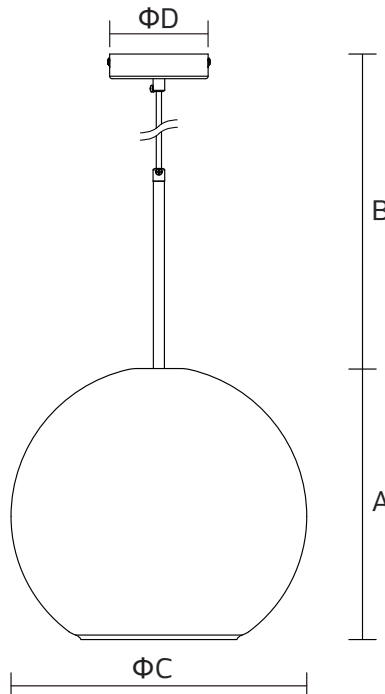

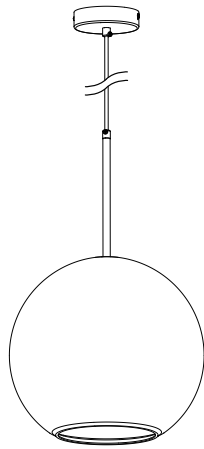
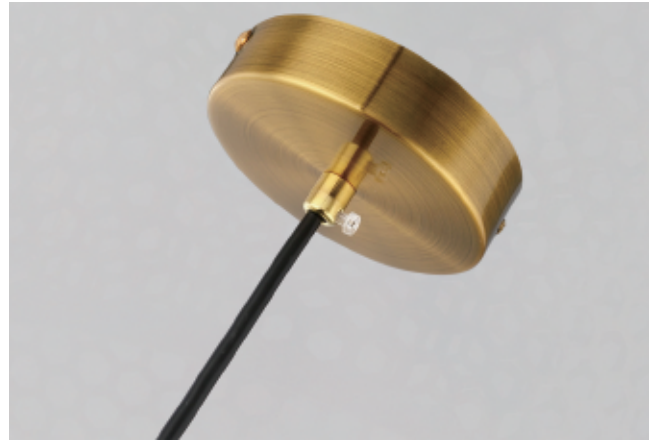

Description:
Lamp Accessories

Main material:
Metallic iron+glass



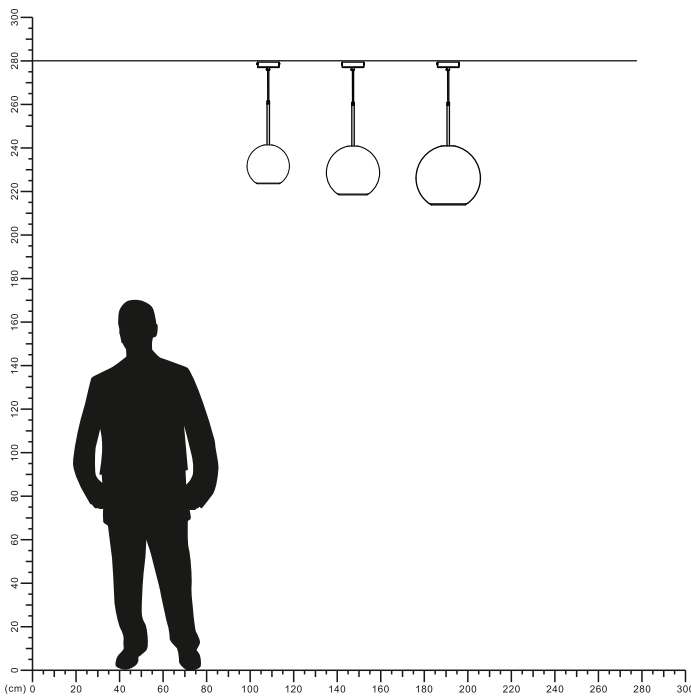

Specification
Artificially blown glass technology, smooth and free of impurities on the surface, combining texture and art. Electroplated ceiling plate, wrought iron, electroplated process treatment, solid and stable. Presented in the form of lanterns, endow lighting sense of art, cleverly combining fashion and classicism.

IP 20

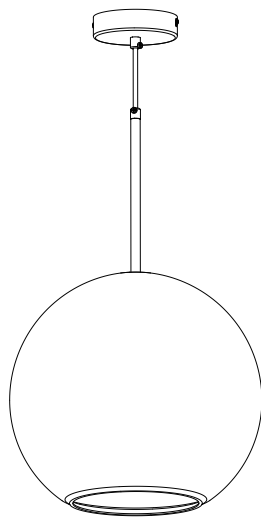
Applications
• Bedroom
• restaurant
• living room





-  X 2
-  X 2
-  X 2
-  X 2
-  X 6

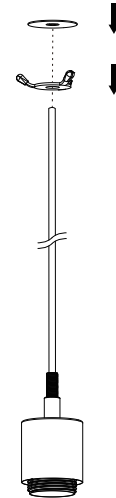

1

Place the flat plate support mouth

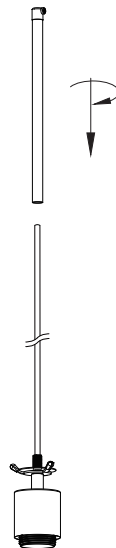

2

Screw down the boom

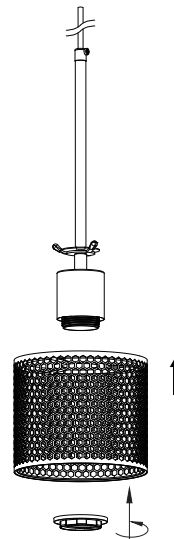

3

Put away lamp canister and tighten the spiral ring

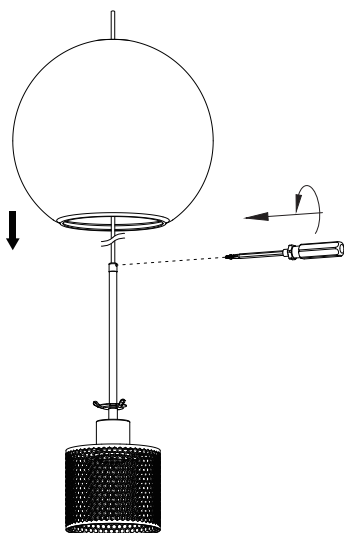

4

Loosen the screws, put on the lampshade, and then tighten the screws

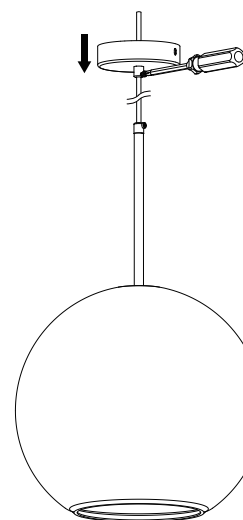

5

Insert the suction tray and tighten the screws

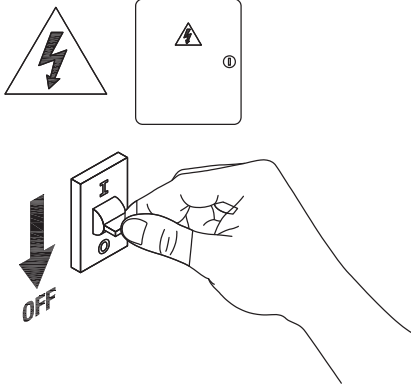

6

Turn off the power

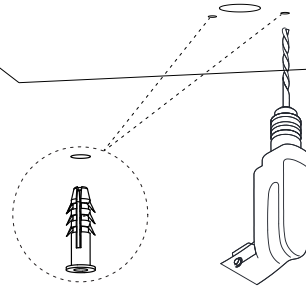

7

Drill holes in the wall insert expansion screws

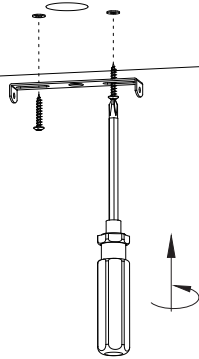

8

To install the hanging board

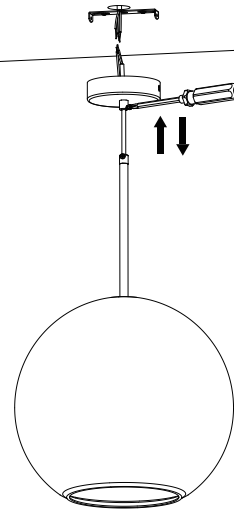

9

Adjust the length of the line according to the use tighten the screws

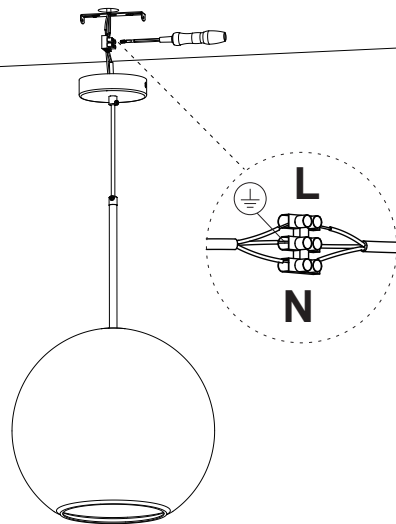

10

Connecting the power cord

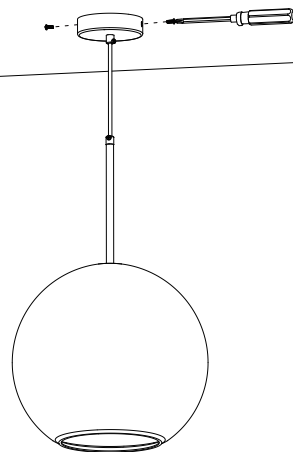

11

and tighten the screws to secure the lamp body

